

LEE

LEE PRECISION, INC.

LEE RELOADING
2025



◀ INTRODUCING THE ▶
**LEE MICROMETER
ADJUST SCREW**

*PRECISION DOESN'T NEED
TO BE EXPENSIVE*

PAGE 16

leeprecision.com

Classic Lee Loader THE KIT THAT STARTED IT ALL



MORE SHOOTERS have chosen the famous Lee Loader for their first reloading tool than any other. They realize it is all they need for good, accurate ammunition. In fact, at one time ammunition loaded with a Lee Loader held a world record listed in the GUINNESS BOOK OF WORLD RECORDS for more than seven years. Millions upon millions of rounds have been reloaded with the famous Lee Loader. It's the perfect tool for those who wish to simply try reloading, because it will pay for itself in just an hour or two. Find out for yourself how much fun it is to reload with the Lee Loader. Everything you need to begin loading one caliber! Use to reload cases that have been fired from your gun.

LEE LOADER 46.98

LEE LOADER SIZES	
223 Remington	90232
243 Winchester	90235
270 Winchester	90240
7.62x54 Russian	90243
30/30 Win (30 Rem.)	90244
308 Winchester	90245
30/06 Springfield	90248
303 British	90247
45/70 Government	90264
9mm Luger	90254
38 Special	90257
357 Magnum	90258
*44 Magnum	90260
*45 ACP	90262
*45 Colt	90263

* Calibers requiring considerable force for sizing.

INDEX

2-3	Lee Loader Reloading Basics
4	Reloading Stand Bench Plate
5	Modern Reloading II
6-7	Pistol Reloading Dies
8	Breech Lock Carbide Dies
9	Pistol Crimp Dies
10	Ultimate Rifle Die Set
11	Rifle Full Length Sizing Dies
12	Rifle Breech Lock Dies
13	Rifle Collet Neck Sizing Dies
14	Rifle Factory Crimp Dies
15	Rifle Large Caliber Reloading
16	Reloading Die Accessories
17	Reloading Press Overview
18	Progressive Press Options
19	Compact Press Overview
20	Challenger III Press Kits
21	Classic Cast 50 BMG Press and Kit
22	Ultimate Turret Press Kit
23	Classic Turret Press Kit
24	Value Turret Press Safety Prime
25	LEE PRO 1000
26	LEE PRO 4000
27	LEE SIX PACK PRO
28	Inline Bullet Feeder
29	The APP Deluxe APP KIT
30	APP Processing Accessories
31	Case Trimming Case Length Gauge Quick Trim
32	Case Trimming Quick Trim
33	Case Conditioning Tools Bulge Buster Kit
34	Auto Bench Prime Auto Prime
35	Deluxe Perfect Powder Measure Safety Scale Original Perfect PM
36	Pro Auto Disk Powder Measure Auto Drum Powder Measure
37	Melters Pro 4-20 Magnum Melter Precision Melter Production Pot IV
38	Bullet Lube and Sizing
39	Rifle Bullet Molds
40-41	Pistol Bullet Molds
42	Black Powder Bullet Molds
43	Slug Molds Buckshot Molds Load-All II
44	LEE Guarantee

RELOADING

SIZE

HANDGUN

REMOVING spent primer and **RESIZING** case can be accomplished by using any reloading press

Pistol Sizing Die

Breech Lock Challenger III Press
pg 20

PRIME

HANDGUN

INSTALL PRIMER
Can be done on press or by hand

On press: Prime with Lever Prime System
pg 20

FULL LENGTH SIZE OR COLLET NECKSIZE TRIM

RIFLE

NOTICE how the case neck is sized as case is withdrawn from die over the expander

Rifle Full Length Sizing Die
LUBRICATE an inspected, clean case.

Rifle Collet Necksizing Die
No lube required. Cases must be fired through your gun only.

RIFLE

FOR SAFETY SAKE
CHECK CASES for proper trim length. Chamfer inside case neck to allow easy bullet installation.

Case Conditioning Kit
pgs 31-32

Deluxe Quick Trim, trim and chamfer simultaneously
pgs 31-32

RIFLE

Hand Prime with Auto-Prime
pg 34

Priming with Lee Auto-Bench Prime
pg 34

Press Priming with the Lee Deluxe APP Kit
pg 29

Lee Precision, Inc.
4275 Highway U
Hartford Wi 53027
262 673 3075

RELOADING IS AN ENJOYABLE HOBBY, saves you money — and no manufacturer saves you more than Lee Precision, Inc. Our mission is simple: produce the best American made value in reloading tools. Our great prices come from patented, innovative designs. We are thankful to say that Lee Precision products are cast, machined and assembled in the USA.

A reloading press and a set of Lee Dies are all you need to start reloading. Lee Dies come complete with powder dipper, shell holder and instructions, along with

comprehensive load data that tells you how much and what type of powder to use. Dies and presses last a lifetime, so buying what your budget allows makes the most sense. For those with a workbench, consider our Lee Bench Plate for the ultimate convenience in mounting your presses. If you don't have a workbench, consider the Lee Reloading Stand, compact and very sturdy. If you have no loading equipment and are just getting started, you must consider that these basic steps need to be taken below.



Check out our complete line of reloading and casting equipment on our website, then visit your local merchant.

If not blessed with a local dealer, one of the many online dealers will quickly and economically fill your order.

G S E Q U E N C E

CHARGE

EXPAND CASE MOUTH AND CHARGE POWDER.
Lee handgun dies are unique in that you can charge powder during this operation





HANDGUN Powder Through Expanding Die

Auto Drum Powder Measure pg 36

SEAT & CRIMP

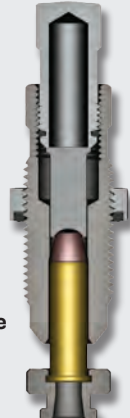
HANDGUN Bullet Seating Die



SEAT AND CRIMP THE BULLET

OPTIONAL

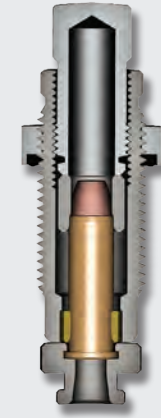

HANDGUN CARBIDE FACTORY CRIMP DIE
Easy to adjust crimp and carbide ring post sizes the case. pg 9

CHARGE

CHARGE POWDER





Powder Funnel and Dippers pg 35

Deluxe Perfect Powder Measure pg 35

SEAT

RIFLE Easy Adjust Dead Length Bullet Seating Die



SEAT THE BULLET

CRIMP



FACTORY CRIMP DIE
In most circumstances will improve velocity, uniformity and in all cases, factory-like utility & dependability. pg 14

Lee Reloading Stand

At last, a reloading stand built just for your reloading needs. The sturdy powder coated steel stand places your press at the perfect counter stool or standing height. Three-leg design assures absolute stability regardless of the floor condition. Rubber tipped legs suitable for any surface.

The thick steel top is fitted with the patented, quick change Lee Bench Plate System with steel base block to fit all Lee metallic presses. The stand also includes a sturdy steel shelf with two bench plate receivers that will neatly and securely store your extra presses or mountable accessories. Each leg has eight mounting holes that allow you to accessorize your stand with a multitude of bins, shelves and/or accessory racks.

Dimensions 39" high x 26" wide x 24" deep

90688 190.00

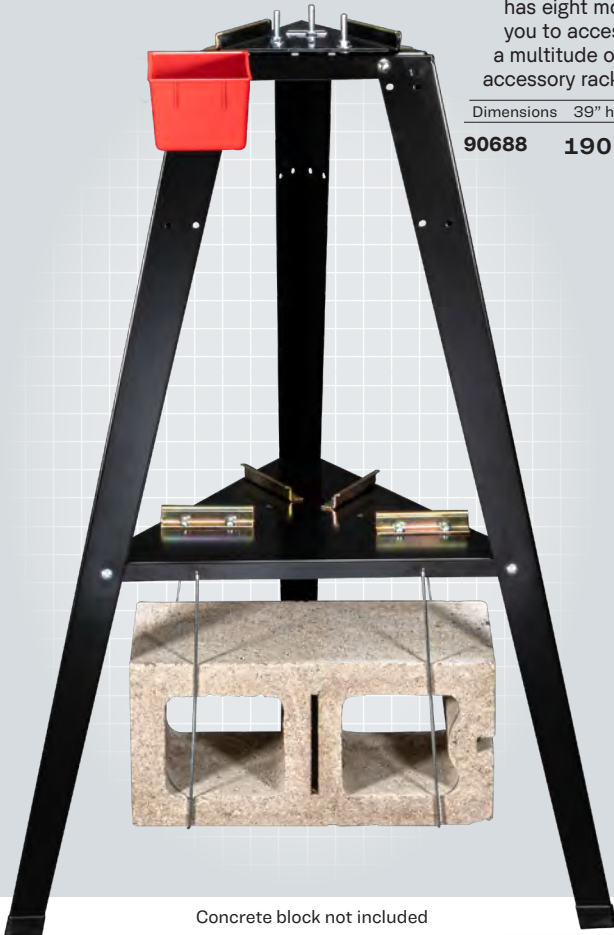

Concrete block not included



ACCESSORIES



Die Rack

Sturdy steel rack with fasteners designed for the Lee Reloading stand. Conveniently holds your dies at the ready, especially helpful when loading small batches of ammo with frequent die changes. Can also be wall or bench mounted.

90680 16.00

Bin and Bracket

Sturdy steel bracket and parts bin. Includes fasteners to allow direct mounting to the Lee Reloading stand, or workbench. Perfect for holding bullets, cases and loaded rounds.

90687 14.00



Ammo Bins

6 PACK

Fits common bin brackets. Exclusive closed front provides 100% case capture. 4" wide x 6" long x 3" tall.

91868 15.00



Steel Base Block

Rigid, powder coated steel construction. First choice for mounting all current Lee Presses. Works with the Lee Reloading Stand and Bench Plate. Fasteners for mounting one Lee reloading press are included.

90267 17.00



JUST REMOVE

AND REPLACE

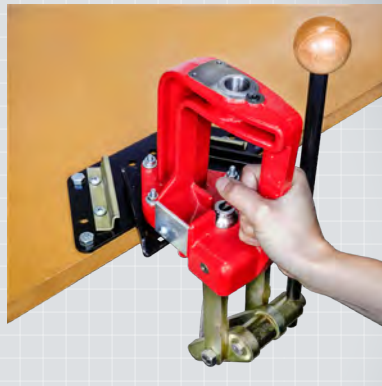
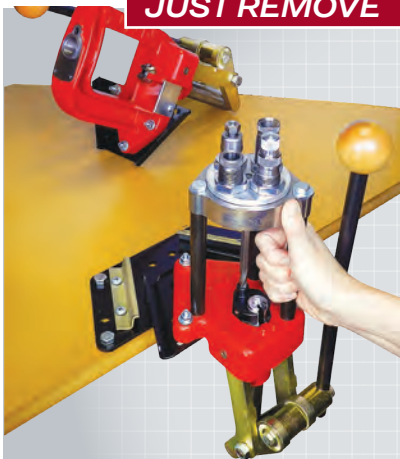

Patented design allows instant press change. So sturdy you can resize the monster 50 BMG case, then quickly switch to a smaller press for priming or other operations. Trapezoidal base block slides into perfect register and made immovable with the quick tightening of four bolts.

Lee Bench Plate



Includes steel base block with holes to mount any Lee press. Powder coated, thick steel plate mounts quickly and securely to any bench or tabletop. Wide steel plate distributes load, adding rigidity to the lightest bench top.

LEE BENCH PLATE 90251 43.00

PISTOL RELOADING DIES

LEE HANDGUN DIES FEATURE A CARBIDE SIZING DIE, SIMPLY THE BEST WAY TO RESIZE STRAIGHT WALLED HANDGUN CARTRIDGES.

Lee Dies reload cartridges better, easier, more accurately and with fewer problems!

STORAGE IS EASY

LEE DIES ARE PACKED IN A FITTED BOX THAT ALLOWS DIES TO BE RETURNED TO THE BOX ADJUSTED WITH OR WITHOUT THE LEE BREECH LOCK BUSHING OR SPLINE DRIVE BUSHING INSTALLED

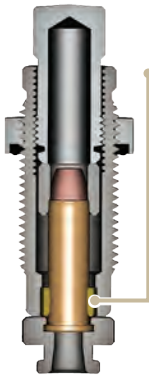

CARBIDE FACTORY CRIMP DIE

Carbide ring in base resizes any portion of case that exceeds factory new dimensions. Floating crimp ring is finger adjustable to provide the perfect crimp.

HARDENED STEEL SHELLHOLDER

Others charge \$18.00 for this item!

Exclusive feature to Lee
POWDER MEASURE & CHARGE TABLE

Exclusive feature to Lee
POWDER THROUGH EXPANDING DIE



Only Lee Dies permit charging the case while expanding the case mouth. Every Lee Pistol Die Set includes this **Powder Through Expanding Die** at no extra cost. The powder funnel adapter can be replaced with a Lee case actuated Powder Measure (pg. 36) for fully automatic powder charging while the case mouth is being expanded.



44 SPECIAL

Cartridge	Case	Grain	Velocity	Pressure	Temp	Notes
44 S&W	44 S&W	180	1100	15000	70	
44 S&W	44 S&W	200	1150	15000	70	
44 S&W	44 S&W	220	1200	15000	70	
44 S&W	44 S&W	240	1250	15000	70	
44 S&W	44 S&W	260	1300	15000	70	
44 S&W	44 S&W	280	1350	15000	70	
44 S&W	44 S&W	300	1400	15000	70	
44 S&W	44 S&W	320	1450	15000	70	
44 S&W	44 S&W	340	1500	15000	70	
44 S&W	44 S&W	360	1550	15000	70	
44 S&W	44 S&W	380	1600	15000	70	
44 S&W	44 S&W	400	1650	15000	70	
44 S&W	44 S&W	420	1700	15000	70	
44 S&W	44 S&W	440	1750	15000	70	
44 S&W	44 S&W	460	1800	15000	70	
44 S&W	44 S&W	480	1850	15000	70	
44 S&W	44 S&W	500	1900	15000	70	
44 S&W	44 S&W	520	1950	15000	70	
44 S&W	44 S&W	540	2000	15000	70	
44 S&W	44 S&W	560	2050	15000	70	
44 S&W	44 S&W	580	2100	15000	70	
44 S&W	44 S&W	600	2150	15000	70	
44 S&W	44 S&W	620	2200	15000	70	
44 S&W	44 S&W	640	2250	15000	70	
44 S&W	44 S&W	660	2300	15000	70	
44 S&W	44 S&W	680	2350	15000	70	
44 S&W	44 S&W	700	2400	15000	70	
44 S&W	44 S&W	720	2450	15000	70	
44 S&W	44 S&W	740	2500	15000	70	
44 S&W	44 S&W	760	2550	15000	70	
44 S&W	44 S&W	780	2600	15000	70	
44 S&W	44 S&W	800	2650	15000	70	
44 S&W	44 S&W	820	2700	15000	70	
44 S&W	44 S&W	840	2750	15000	70	
44 S&W	44 S&W	860	2800	15000	70	
44 S&W	44 S&W	880	2850	15000	70	
44 S&W	44 S&W	900	2900	15000	70	
44 S&W	44 S&W	920	2950	15000	70	
44 S&W	44 S&W	940	3000	15000	70	
44 S&W	44 S&W	960	3050	15000	70	
44 S&W	44 S&W	980	3100	15000	70	
44 S&W	44 S&W	1000	3150	15000	70	

LEE SAFETY POWDER SCALE

BACK OUT BULLET SEATING & EXPANDING DIE 1% ADDITIONAL TURN TO LOAD THE 44 MAG

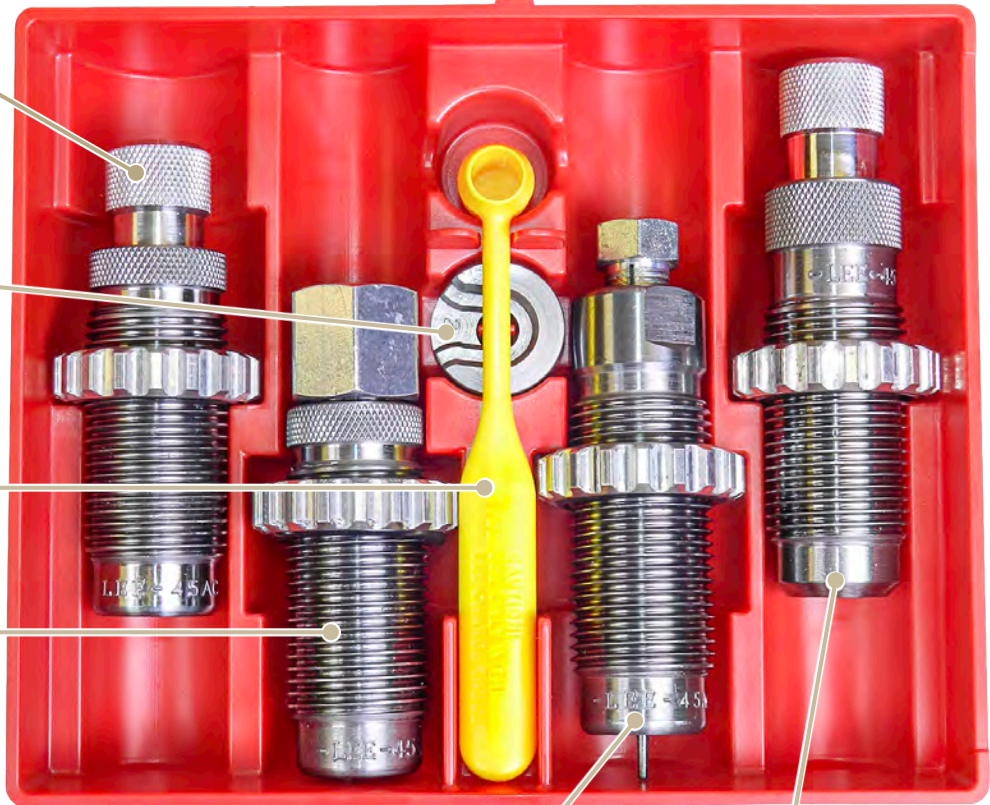

Exclusive feature to Lee
CONTOUR GROUND CARBIDE SIZING DIE

BULLET SEAT & FEED DIE

Carbide Sizer

All Lee straight walled pistol dies have tungsten carbide sizer rings. Carbide is so hard that it can only be ground and polished with diamond wheels. This hard diamond polished surface eliminates the need for case lubrication—they never wear out. Exclusive contour grind sizes closer to the rim than any other brand. The collet held decapper is nearly unbreakable even if misadjusted or depriming crimped military cases. The decapper clamp accurately centers the decapper in the die. Should you over stress it for any reason, it harmlessly slides up without breaking. Easily reset with no limit to the times it can be reset.

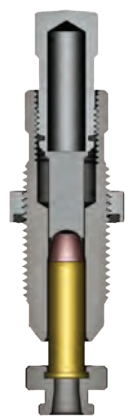

Bullet Seat and Feed Die

Universal free floating seating plug works with nearly any point style bullet. No need to change seater plugs for different nose types. Finger adjustable seating depth eliminates fumbling with pliers, lock nuts and screwdrivers to make simple seating depth adjustment.

ACCESSORY

A second pin for 1/3 more
DOUBLE END DECAPPING PIN

PISTOL 91909 4.00

ONLY LEE DIES COME COMPLETE WITH POWDER MEASURE and CHARGE TABLE

PISTOL DIE SETS

We use a solid carbide insert, ground to a special contour that does not leave the objectional belt mark on the case, common to ordinary carbide dies. With a carbide sizer, no case lube is needed, and you don't even have to clean your cases.

NO NEED FOR A TAPER CRIMP DIE; BETTER ACCURACY WITH LEE DIES.

Taper crimp dies are used to correct the problems caused by the improper expanding plug design or adjustment. They distort the bullet shank and reduce accuracy. Because the Lee Expander flares the minimum amount, consistent with easy bullet insertion, all of the flare is removed with the bullet seating die, thus eliminating the need for a taper crimp die.

Lee Deluxe Pistol 4-Die Set

Combines the world's most popular carbide three-die set with the Lee Carbide Factory Crimp Die at a great price. No other die set at any price produces more reliable or accurate ammo.

By separating seating and crimping operations, you benefit by greatly simplified adjustment. More importantly, the Carbide Factory Crimp Die post sizes your case, assuring any round that passes through the die will chamber properly in your gun. This, plus all the other exclusive features — make this the best die set money can buy!

LEE DELUXE PISTOL 4-DIE SET

78.00



CARBIDE FULL LENGTH SIZING DIE, POWDER THROUGH EXPANDING DIE, BULLET SEAT AND FEED DIE AND CARBIDE FACTORY CRIMP DIE.

MICROMETER ADJUST SCREW

Accessory Handgun **92150 20.00**
See page 16

The **CARBIDE & STEEL THREE DIE SETS** work fine when using a quality controlled source of brass, like cases fired only in your gun. More care is required when adjusting the bullet seat and crimp die, as seating and crimping occur simultaneously. Bullet diameter control is important when not using the factory crimp.



LEE CARBIDE PISTOL 3-DIE SET 49.00

CARBIDE FULL LENGTH SIZING DIE, POWDER THROUGH EXPANDING DIE AND BULLET SEAT & FEED DIE.

LEE STEEL PISTOL 3-DIE SET 46.98

STEEL FULL LENGTH SIZING DIE, POWDER THROUGH EXPANDING DIE, BULLET SEAT AND FEED DIE, AND RESIZING LUBRICANT

Same features as our premium carbide sets, except case must be lubricated.



LEE STEEL PISTOL 2-DIE SET 46.98

STEEL FULL LENGTH SIZING DIE, BULLET SEAT AND FEED DIE, AND RESIZING LUBRICANT PACKET

Same features as our premium carbide sets, except case must be lubricated.



FREE SHELLHOLDER

The price of Lee Dies include a FREE SHELL HOLDER of the proper size. Some manufacturers charge \$18.00 extra for this necessary part.

	DELUXE PISTOL 4-DIE SET	CARBIDE 3-DIE SET	STEEL 3-DIE SET	STEEL 2-DIE SET
	78.00	49.00	46.98	46.98
22 TCM				90803
5.7 x 28				90603
4.6 x 30				91986*
25 ACP		90568		
30 M1 Carbine		906260		
30 Luger			90754	
30 Mauser			90755	
30 Super Carry	91888			
7.62 Tokarev			90769	
32 ACP		90622		
32 S & W		90696		
32 S & W Long		90624		
32 H & R Mag or 327 Federal		90809		
32/20			90751	
38/40			90761	
9mm Makarov		90176		
9mm Luger	90963	90509		
9 x 21			91891*	
357 Sig			90270	
38 Short / Long Colt		90276		
38 Super / 38 ACP		90623		
380 Auto	90447	90625		
38 S & W		90569		
38 Special / 357 Mag	90964▼	90510		
40 S&W / 10mm Auto	90965▼	90799		
41 Mag		90628		
429 Desert Eagle			90796	
44 Special / 44 Mag	90966▼	90516		
44 Russian		90293		
44/40			90564	
45 Colt *	90967	90514		
45 ACP	90968	90513		
45 Auto Rim		90808		
45 Schofield		90323		
400 Cor Bon			90430*	
455 Web Mark II		90764		
45 Win Mag		90810		
454 Casull		90795		
45 Gap		90498		
460 S & W		90344		
480 Ruger ‡		90499		
50 Action Express			90329	
500 S&W		90288		

▣ Can be used to load magnum cases ▣ Can be used to load maximum cases ▼ Includes load data for magnum cases * can be used to load the 475 Linebaugh
*can be used to load the 454 Casull *These dies do not include load data ◆ 30 M-1 Carbine \$16.00 extra

BREECH LOCK DIES

BEST VALUE FOR LEE BREECH LOCK PRESS OWNERS



LEE BREECH LOCK CARBIDE DIES

Your first choice for Lee reloading presses. Features colored Smart Lock bushings already installed on dies. Integrated o-ring keeps die settings firmly in place, yet remain finger adjustable. Color coded bushings provide easy die identification. Set up your dies once, and keep your die adjustments set. Return them to the included box for convenient storage.

Includes:

- Universal Shell Holder
- Instructions with Load Data
- Powder Dipper
- Instructions with comprehensive load data

LEE BREECH LOCK CARBIDE 4-DIE SET 85.00

COLOR CODED SMART LOCK BUSHINGS FOR NO TOOL DIE ADJUSTMENT, CARBIDE FULL LENGTH SIZING DIE, POWDER THROUGH EXPANDING DIE, BULLET SEAT AND FEED DIE AND CARBIDE FACTORY CRIMP DIE.

LEE BREECH LOCK CARBIDE 3-DIE SET 59.00

COLOR CODED SMART LOCK BUSHINGS FOR NO TOOL DIE ADJUSTMENT, CARBIDE FULL LENGTH SIZING DIE, POWDER THROUGH EXPANDING DIE, AND BULLET SEAT AND FEED DIE.



FREE SHELLHOLDER

The price of Lee Dies include a FREE SHELL HOLDER of the proper size. Some manufacturers charge \$18.00 extra for this necessary part.

BREECH LOCK CARBIDE 4-DIE SET

BREECH LOCK CARBIDE 3-DIE SET

	85.00	59.00
32 S & W Long		91876
9mm Luger	91934	91882
38 Super / 38 ACP		91879
380 Auto	91935	91877
38 Special/357 Mag	91936	91878
40 S& W/ 10mm Auto	91937	91880
44 Special / 44 Mag	91938	91881
45 Colt	91939	91884
45 ACP	91940	91883



MICROMETER ADJUST SCREW

Accessory
Handgun 92150 20.00
See page 16



BIG GUN INSPIRED BREECH LOCK QUICK CHANGE STANDARD ON ALL LEE SINGLE STATION PRESSES

Switch dies with a 1/4 turn rather than fourteen or more turns. Loading with a breech lock equipped press is as convenient as a turret press, when loading small quantities of ammunition. Interrupted three-start thread assures dies will return and lock into the exact same position.



EVERYTHING YOU NEED TO START RELOADING

Hand Loader Kit

THE PERFECT PORTABLE RELOADING PRESS KIT
Unlock your reloading potential—anywhere, anytime! No wasted time mounting to a workbench. Pack it in the molded storage box when finished. Don't let limited space hold you back. With our compact and portable solution, you can enjoy the freedom of reloading wherever you are. Hand Loader Kit includes: Breech Lock Hand Press, Breech Lock Reloading dies, Breech Lock Ram Prime. Select from popular cartridges below. \$166.98 value if purchased separately.

KIT INCLUDES:

- BREECH LOCK HAND PRESS
- BREECH LOCK RAM PRIME
- BREECH LOCK 3-DIE RELOADING SET

99.98

9MM LUGER	92114
38 SPECIAL 357 MAGNUM	92115
45 ACP	92117
223 REMINGTON	92118

Change dies instantly WITH A TWIST OF THE WRIST



BREECH LOCK BUSHINGS

Breech lock bushings fit all Lee Breech Lock presses. Allows instant, accurate die changes.

90600 2-PK. 16.00



SPLINE DRIVE BUSHINGS

Breech lock quick change bushing with integral lock collar provides unmatched precision and convenience when adjusting dies. Split clamp positively locks die into position.

90063 2-PK 16.00



Buy more for greater savings



90095 4-PK 27.00



SMART LOCK BUSHINGS

Standard on Breech Lock Die Sets
No tool die adjustments needed.
91933 4-PK 27.00

COLOR CODED FOR QUICK, POSITIVE DIE SELECTION

CARBIDE FACTORY CRIMP DIE

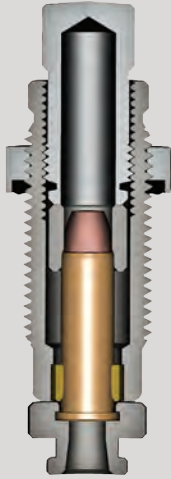

Lee Carbide Factory Crimp Die

A carbide sizer sizes the cartridge while being crimped, so every round will positively chamber freely with factory like dependability. The adjusting screw quickly and easily sets the desired amount of crimp. It is impossible to buckle the case as with a conventional bullet seating die. Trim length is not critical so this extra operation takes less time than it would if cases were trimmed and chamfered.

Revolver dies roll crimp with no limit as to the amount. A perfect taper crimp is applied to auto-loader rounds. The crimper cannot be misadjusted to make a case mouth too small to properly head-space. A firm crimp is essential for dependable and accurate ammunition — it eliminates the problems of poor ignition of slow burning magnum powders.

CARBIDE FACTORY CRIMP DIE
28.98



**INCLUDED
WITH
DELUXE
4-DIE SETS**

*For handgun
ammunition
that must work*

	CRIMP STYLE	Carbide Factory Crimp Die
32 ACP · 32 S&W Long 32 H&R Mag · 327 Federal	ROLL	90067
9mm Makarov	TAPER	90807
9mm Luger	TAPER	90860
30 Super Carry	TAPER	91890
38 Super & 38 ACP	TAPER	90866
380 Auto	TAPER	90867
38 Special	ROLL	90861
357 Magnum	ROLL	90861
40 S&W & 10mm Auto	TAPER	90862
41 Magnum	ROLL	90416
44 Special	ROLL	90863
44 Magnum	ROLL	90863
44 Russian	ROLL	90863
45 Colt	ROLL	90865
45 ACP · 45 Auto Rim · 45 GAP · 45 Win Mag	TAPER	90864
454 Casull	ROLL	90865



Short Bottle Neck Collet Style Factory Crimp Die

Incorporates a collet to apply a factory type crimp to the case. Makes these very difficult to crimp cartridges a delight to reload. Bullets do not need a crimp groove, as the collet is so powerful it will form one.

**SHORT BOTTLE NECK COLLET STYLE
FACTORY CRIMP DIE**
25.00

5.7x28 FN	90725
22 TCM	90087
30 Luger	90175
30 Tokarev & 30 Mauser	90086
357 Sig	90076
400 CorBon	90173



Collet Style Factory Crimp Die

Popular with cast bullet shooters that wish to use oversize bullets; also very popular when reloading heavy recoiling revolvers. No other crimping system can apply as secure a crimp as the Lee Collet style Factory Crimp Die. No crimping groove required in jacketed or cast bullets, this die is so powerful it forms a crimp groove if one is not present.

COLLET STYLE CRIMP DIE **15.98**

30 M1 Carbine · 32/20	90421
357 Magnum	90813
44 Magnum	90930
45 Colt	90302
460 S&W	90926
500 S&W	90931



Taper Crimp Die

The Lee Taper Crimp Die is hardened steel, designed to overcome crimp problems caused by poor die design. These dies offer little or no advantage when used with 1986 or newer Lee Dies. Jacketed bullets must have a crimp groove.

TAPER CRIMP DIE **13.98**

9mm Luger	90780
38 Super & 38 ACP	90780
380 Auto	90780
38 Special	90781
357 Magnum	90781
40 S&W & 10mm Auto	90782
44 Special	90784
44 Magnum	90784
45 Colt	90786
45 ACP · 45 Auto Rim · 45 GAP · 45 Win Mag	90785
455 Web Mark II	90785
454 Casull	90786

ULTIMATE RIFLE DIE SET

the BEST INTERNAL FINISH IN THE INDUSTRY

ALL LEE DIES ARE MACHINE HONED TO THE SMOOTHEST POSSIBLE FINISH

Don't confuse this with the surface polish that's used by most manufacturers. A polish simply makes a shiny surface. It's like trying to sand wood without backing under the sandpaper. The inside surface of Lee dies are progressively honed to a fine finish with no waves or ripples.

LEE OFFERS THE MOST COMPLETE DIE SETS

FREE SHELL HOLDER
SOME CHARGE OVER \$18.00 FOR THIS NECESSARY PART

FREE COMPREHENSIVE LOAD DATA
PRICELESS ON SOME CARTRIDGES

FREE POWDER DIPPER

EASIEST TO ADJUST DIES
WITH FINGER TIGHTEN LOCK RINGS

BUILT-IN STUCK CASE REMOVER

CASE SIZING LUBRICANT
INCLUDED WITH 2-DIE, 3-DIE & ULTIMATE DIE SETS

TIGHTEST TOLERANCE IN THE INDUSTRY

EXCLUSIVE FEATURE FACTORY CRIMP DIE
FIRMLY CRIMPS BULLET IN PLACE AND APPLIES A FACTORY-STYLE CRIMP

NO TOOL REQUIRED
FINGER ADJUSTABLE
BULLET SEATING



CASE SIZING LUBRICANT

BUILT-IN STUCK CASE REMOVER

EXCLUSIVE FACTORY CRIMP DIE

ULTIMATE RIFLE DIE SET

Choose this die set for maximum versatility. Features a FULL LENGTH-RESIZING DIE to return brass to factory new dimensions, perfect for reloading brass fired in other guns. The COLLET NECKSIZING DIE is used on your fire formed brass, giving you best possible accuracy. No case lube required and cases last almost forever. The EASY ADJUST DEAD LENGTH BULLET SEATING DIE foolproofs the bullet seating adjustment, and assures perfect seating depth every time. THE FACTORY CRIMP DIE provides a secure crimp on bullets with or without a crimp groove. In most cases, it helps accuracy by providing a uniform higher start pressure and gives the finished cartridge factory-like accuracy and dependability. The set is complete with shell holder, powder measure and famous Lee load data featuring all common brands of powder organized in an easy to read logical format.

LEE ULTIMATE RIFLE DIE SET 70.00

INCLUDES COMPLETE COLLET DIE SET PLUS FACTORY CRIMP DIE, FULL LENGTH RESIZING DIE & RESIZING LUBRICANT.

FULL LENGTH SIZING DIE

THE LEE **EasyX** EXPANDER

COLLET TYPE DECAPPER CLAMP HOLDS EASY X EXPANDER PERFECTLY CENTERED IN THE DIE. ALLOWS DECAPPER TO SLIDE HARMLESSLY UP PREVENTING DECAPPER BREAKAGE IF AN OBSTRUCTION IS ENCOUNTERED

STURDY SHANK SO STRONG YOU CAN DRIVE OUT A STUCK CASE WITHOUT DAMAGE

TAPERED AREA EXPANDS SUB CALIBERS WHEN CASE FORMING. QUICKLY AND EFFORTLESSLY REFORMS DENTED OR SQUASHED NECKS

SUPER STRONG INTEGRAL DECAPPER IS ALMOST UNBREAKABLE

LONG GUIDED NECK EXPANSION AREA LOCATED TO BEGIN EXPANDING AS SOON AS THE NECK LEAVES THE DIE NEAR THE PRESSES' MAXIMUM MECHANICAL ADVANTAGE



ONLY LEE DIES COME COMPLETE WITH POWDER MEASURE and CHARGE TABLE

HARDENED STEEL SHELLHOLDER

Others charge \$18.00 for this item!

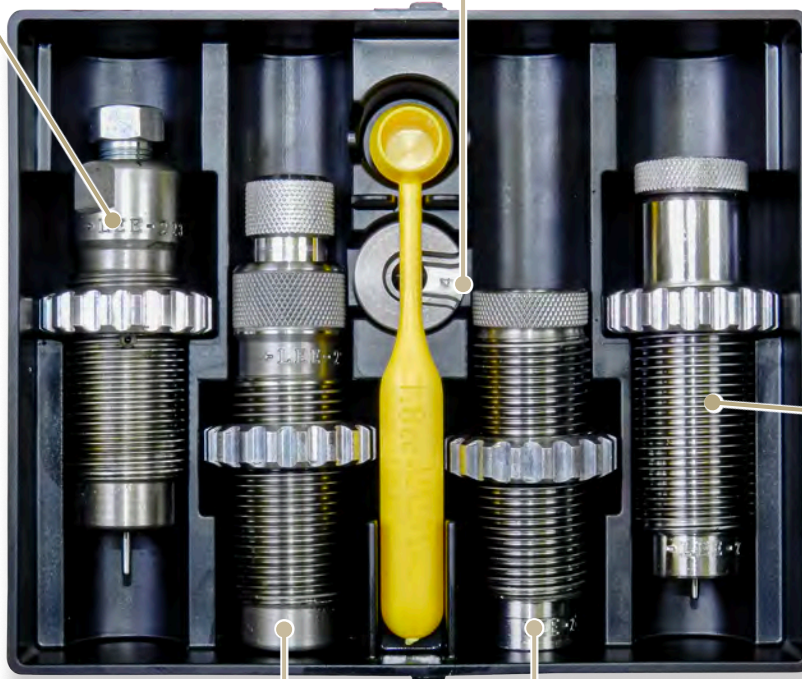

EASY ADJUST DEAD LENGTH BULLET SEATING DIE

Universal free floating seating plug works with nearly any point style bullet. No need to change seater plugs for different nose types. Finger adjustable seating depth eliminates fumbling with pliers, lock nuts and screwdrivers to make simple seating depth adjustment.

FACTORY CRIMP DIE

The only effective way to crimp bottleneck rifle cartridges. Our Factory Crimp Die should be used on all loads used for hunting. Applying a factory crimp will always improve the utility of the cartridge, and in most cases, will also improve the accuracy.

CARTRIDGE	
222 Remington	92058
223 Remington	90694
22/250	90739
243 Winchester	90556
6.5 Creedmoor	90939
270 Winchester	90593
7mm Rem Mag	90679
30/30 Win	90693
308 Winchester	90695
30/06	90736
300 Win Mag	90738
303 British	91875
8x57 Mauser	92069

COLLET NECKSIZING DIE

IN ADDITION TO BEST ACCURACY, YOU GET THESE BENEFITS

- NO CASE LUBRICATION REQUIRED
- REDUCED OR ELIMINATES CASE TRIMMING
- TEN TIMES INCREASED CASE LIFE
- UNMATCHED SPEED AND CONVENIENCE
- MINIMUM BULLET RUNOUT
- MOST UNIFORM NECK TENSION

RGB DIES
REALLY GREAT BUY!



Compare to other brands costing twice as much and you'll recognize what a fantastic bargain they are. We offer these only to show that when you buy Lee Dies —without all of the extras Lee customers have come to expect—the price is significantly lower, yet the quality is the best.

RGB SERIES DIES ONLY 30.98

RGB Die Sets

CARTRIDGE	RGB DIES	CARTRIDGE	RGB DIES	CARTRIDGE	RGB DIES
222 Remington	90870	6.5 Creedmoor	91556	308 Winchester	90879
223 Remington	90871	270 Winchester	90875	30/06	90880
22/250	90872	7mm Rem Mag	90876	300 Win Mag	90881
243 Winchester	90873	7.62 x 39 Russian	90877	303 British	90882
6.5x55 Swed. Mauser	90874	30/30 Winchester	90878	8x57 Mauser	90883

THESE DIES ARE A REALLY GREAT BUY. THEY COST LESS, BECAUSE UNLIKE OTHER DIE MAKERS, WE INCLUDE \$32.00 WORTH OF EXTRAS IN OUR FULL LENGTH SIZING DIES.



MICROMETER ADJUST SCREW

Accessory
Rifle 92215 20.00
Large Rifle 92218 20.00
See page 16

Full Length Sizing Dies

Produce factory-like ammunition with improved utility and accuracy. The die set also includes full length sizing die, resizing lubricant, an easy adjust dead length bullet seater, shell holder, powder dipper, load data—and all are packed in the nicest storage box ever designed. The extras represent a \$32.00 value. Most are unavailable at any price from other suppliers.



LEE 3-DIE SET 46.98
Includes Factory crimp die.



LEE STRAIGHT WALL 3-DIE SET 46.98
Does not include Factory crimp die; rather, a powder through expanding die.

LEE STRAIGHT WALL 4-DIE SET 62.98

450 Bushmaster includes above, and factory crimp die.

12.7x42mm includes above, and factory crimp die.

Full Length Sizing 3-Die Sets



FREE SHELLHOLDER INCLUDED! The price of Lee Dies includes a FREE SHELL HOLDER of the proper size. Some manufacturers charge \$18.00 extra for this necessary part.

CARTRIDGE	3-DIE SET	CARTRIDGE	3-DIE SET	CARTRIDGE	3-DIE SET
17 Hornet	90096	6.5 Weatherby RPM	91768	7mm PRC	92004
204 Ruger	90417	280 Ackley Improved	90989	300 PRC	90224
22 Hornet	90500	270 Win Short Mag	90572	300 Weatherby Mag	90558
22 ARC	92188	270 Winchester	90505	300 Ultra Mag	90698
22 Creedmoor	92192	224 Valkyrie	90066	7.65 Arg Mauser	90732
218 Bee	90753	6.8 Rem SPC	90427	7.7 Jap	90733
221 Fireball	90549	7/30 Waters	90748	25-303	90793
222 Remington	90501	7 x 57 Mauser	90541	303 British	90547
223 Ack. Imp.	90981	7 x 64 Brenneke	90771	8x57 Mauser	90544
25-45 Sharps	90475	7mm/08	90537	338 ARC	92102
223 Remington	90502	7mm Express/280 Rem	90552	338 Winchester	90546
22/250	90503	7mm Rem Mag	90538	348 Winchester	90760
22/250 Ack. Imp.	90980	7mm STW	90678	358 Winchester	90797
220 Swift	90542	7mm Ultra Mag	90979	35 Remington	90543
243 Winchester	90504	7.5 x 55 Swiss	90767	9.3 x 62 Mauser	90654
6mm Creedmoor	90482	7.5x54 French MAS	90246	375 Raptor	92065
6mm Rem /244 Rem	90540	7.62 x 39 Russian	90565	375 Ruger	90090
25/20 WCF	90750	7.62 x 54 Russian	90731	375 H & H	90559
250 Savage/250-3000	90550	300AAC Blackout	90575	416 Remington	90805
257 Roberts	90551	300 Ham'R	91564	32-20	90751
260 Remington	90298	30/40 Krag	90555	360 Buckhammer	92034*
25/06 Rem	90536	30/30 Win	90506	38-40	90761
26 Nosler	90081	30/30 Ackley Improved	90982	38-55	90762
6mm GT	91956	303 Savage	90756	375 Winchester	90563
257 Ackley Improved	90988	277 Sig Fury	91989*	400 Legend	92079*
6.5 x 55 Swed Mauser	90627	308 Winchester	90507	44/40	90564
6.5 Creedmoor	91821	300 Win Short Mag	90942	444 Marlin	90562
8.6 Blackout	91922*	300 Savage	90545	45/70 Government	90561▼
6.5 Grendel	90557	30/06	90508	350 Legend	90078
6.5 PRC	90662	300 Win Mag	90539	458 Socom	90409
6mm ARC	91562*	300 H & H	90560	458 Win Mag	90800
6.8 Western	91750	6.5-300 Weatherby Mag	90983	450 Bushmaster	90182
				12.7x42mm	90296*
				fifty beowulf	

▼ 45/70 LEVEREVOLUTION REQUIRES PURCHASE OF FACTORY CRIMP DIE # 91639

STRAIGHT WALL 3-DIE SET \$62.98

Full Length Sizing 2-Die Sets



FREE SHELLHOLDER INCLUDED! The price of Lee Dies includes a FREE SHELL HOLDER of the proper size. Some manufacturers charge \$18.00 extra for this necessary part.

CARTRIDGE	2-DIE SET	CARTRIDGE	2-DIE SET	CARTRIDGE	2-DIE SET
17 Remington	90770	7mm Win Short Mag	90573	8mm Lebel	90768
223 WSSM	90446	284 Winchester	90777	338 Ultra Magnum	90927
243 WSSM	90990	7.35 Carcano	90766	338 Lapua	90353
25/35	90778	338/06	90987	350 Rem Mag	90776
25 WSSM	90413	32-40	90758	41 Swiss	90411*
264 Win Mag	90774	32 Winchester Special	90757	35 Whelen	90752
6.5 Carcano	90749	325 WSM	90923	43 Mauser	90806
6.5/300 Win Short Mag	90985	8x56 R Hungarian	90925	43 Spanish	90765
6.5 Japanese	90730				

* THESE DIES DO NOT INCLUDE LOAD DATA



LEE 2-DIE SET 46.98

Same features as our 3-die set, just in limited production. Does not include Factory crimp die; rather, a bullet seat and crimp die.

BREECH LOCK DIES

BEST VALUE FOR LEE BREECH LOCK PRESS OWNERS



**INCLUDES
EXCLUSIVE
LEE FACTORY
CRIMP DIE**

Best Value
FOR BREECH LOCK PRESS OWNERS



Thread your die into a Breech Lock bushing. Once dies are set, you can instantly remove them and replace them to the exact same position. No tools or lock rings are required for reloading die installation. Easy grip splined drive surface allows easy, accurate and fast die installation in your press.

MICROMETER ADJUST SCREW

Accessory
Rifle 92215 20.00
Large Rifle 92218 20.00
See page 16

Lee Breech Lock 3-die Set

Your first choice for Lee reloading presses. Features colored Smart Lock bushings already installed on dies. Integrated o-ring keeps die settings firmly in place, yet remain finger adjustable. Color coded bushings provide easy die identification. Set up your dies once, and keep your die adjustments set. Return them to the included box for convenient storage.

Includes:

- Full Length Sizing Die
- Easy Adjust Dead Length Bullet Seating Die
- Factory Crimp Die
- Universal Shell Holder
- Powder Dipper
- Instructions with comprehensive load data

LEE BREECH LOCK 3-DIE SET 54.00



FREE SHELLHOLDER INCLUDED The price of Lee Dies includes a FREE SHELL HOLDER of the proper size. Some manufacturers charge \$18.00 extra for this necessary part.

CARTRIDGE	
223 Remington	91932
22/250	91948
243 Winchester	91949
6.5 Creedmoor	91920
270 Winchester	91950

CARTRIDGE	
7mm Rem Mag	91951
300 AAC Blackout	91925
30/30 Win	91952
308 Winchester	91953
300 Win Mag	91954

*Change dies
instantly
WITH A TWIST
OF THE WRIST*



BREECH LOCK BUSHINGS

Breech lock bushings fit all Lee Breech Lock presses. Allows instant, accurate die changes.

90600 2-PK. 16.00



Spline Drive Bushings

Breech lock quick change bushing with integral lock collar provides unmatched precision and convenience when adjusting dies. Split clamp positively locks die into position.

90063 2-PK 16.00



Buy more for greater savings



90095 4-PK 27.00



SMART LOCK BUSHINGS

Standard on Breech Lock Die Sets. No tool die adjustments needed.

91933 4-PK 27.00

**COLOR CODED FOR QUICK,
POSITIVE DIE SELECTION**



40th Anniversary Pack

Purchase Challenger and get a FREE set of Breech Lock Reloading dies, select from popular cartridges below. This package is just as complete as the original Lee Loader, in that all you need are powder, bullet and primers. \$179.00 retail value (\$120.00 Challenger Press + \$59.00 Breech Lock Die Set).

120.00

- 9mm Luger **92134**
- 38 Special | 357 Magnum **92130**
- 44 Special | 44 Magnum **92133**
- 45 ACP **92135**
- 223 Remington **92139**



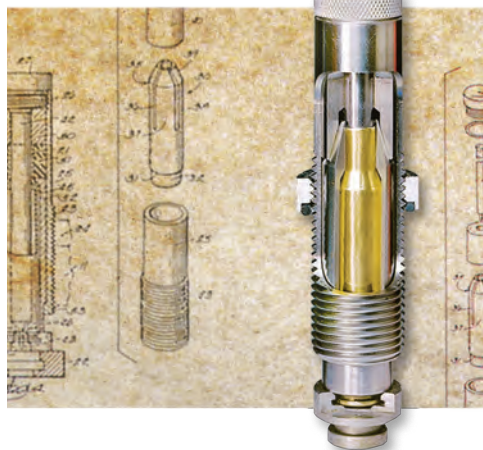

**GUARANTEED
TO LOAD THE MOST
ACCURATE AMMUNITION
ON YOUR MONEY BACK**

- NO LUBRICATION REQUIRED
- GUARANTEED ACCURACY
- EXTENDS CASE LIFE 10X
- FASTEST TO USE
- NO CLEANING REQUIRED

LEE COLLET NECKSIZING DIE

HERE IS NO LOADING SYSTEM that will load more accurate ammunition than Lee Collet Neck Sizing Die. No one but Lee has ever dared make a guarantee like this — **SMALLEST GROUP SIZE OR YOUR MONEY BACK.** Brass neck thickness does not matter. A collet squeezes the case neck against a precision mandrel for a perfect bullet fit with minimum run-out. No case lube is needed. Cases last ten times longer, so the savings on only 35 cases will pay for the dies.

These dies size only the neck to preserve the perfect fit of fire forming. Only reload cases that have been fired in your gun. Not recommended for autoloaders, slide or lever action guns.



LEE COLLET DIE FOR NECK SIZING
ONLY **29.98**

As delivered from the factory, the collet die will grip the bullet with a light press fit with cases of average hardness. Should you desire a tighter fit, you can order an undersized mandrel from the chart above.

Undersized Mandrel
.002" 5.00

CARTRIDGE	COLLET NECK SIZING DIE	.002 UNDERSIZE COLLET MANDREL
17 Remington	91000	
204 Ruger	91001	
22 Hornet	91002	
22 Creedmoor	92148	
222 Remington	91003	
223 Remington	90954	90602
223 Ack. Imp.	90954	90602
22/250	90955	90602
22/250 Ack. Imp.	90955	90602
220 Swift	91004	
243 Winchester	90956	90007
6mm Creedmoor	91005	90007
6mm Rem /244 Rem	91006	90007
257 Roberts	91007	
257 Ack. Imp.	91007	
260 Remington	91008	90069
25/06 Rem	90957	
6.5 x 55 Swed Mauser	91009	90069
6.5 Creedmoor	91012	90069
6.5 PRC	92076	
6mm ARC	92209	
6.5 Grendel	91638	
270 Winchester	90958	90496



45/70 GOVERNMENT COLLET NECKSIZER

Lee 45/70 Government Collet Neck Sizing Die uses a collet to squeeze case neck against a precision mandrel creating a precisely aligned case neck, while reducing run out. Sizes just the case neck and requires no case lubrication. Integrated Breech Lock quick change threading on exterior of die body, works with any Lee Breech Lock reloading press. Select this die if you are reloading brass that has been fired through your gun only.

BENEFITS OF NECK SIZING:

- NO CASE LUBE REQUIRED
- BEST ACCURACY
- STEEL COLLET SQUEEZES FIRED CASE TO PRECISION MANDREL
- EXTENDED CASE LIFE

92082 45.00

CARTRIDGE	COLLET NECK SIZING DIE	.002 UNDERSIZE COLLET MANDREL
7x57 Mauser	91010	90631
7mm/08	91011	90631
7mm Express/280 Rem	91013	90631
280 Ack. Imp.	91013	90631
7mm Rem Mag	91014	90631
7.5 x 55 Swiss	91015	90480
7.62 x 39 Russian	91016	
300AAC Blackout	91017	
300 Ham'R	91636	
30/30 Win	91018	90480
30/30 Ackley Improved	91018	
308 Winchester	90959	90480
300 Win Short Mag	91019	90480
30/06	90960	90480
300 Win Mag	90961	90480
300 H&H	91020	
303 British	91021	
8x57 Mauser	91022	
338 Winchester	91023	
35 Remington	91024	
7mm PRC	91908	
300 PRC	91866	
375 H&H	91025	



Lee Collet Die accuracy contributes to world record

While competing in a regularly sanctioned 1000 Yard Match on July 25th, 1993, Robert Frey established a new 1000 yard World Record. We're honored he used the Lee Collet Die to load his record setting ammunition.

World record breaker Robert Frey commented: "The Lee Collet Neck Sizing Die enables me to get top accuracy from my rifles (match and hunting). The design principle of sizing the case neck to a mandrel is unmatched for accuracy potential by any other dies. It is one of the best ways to make all of my rifles shoot their tightest groups."

FACTORY CRIMP DIES



The Lee Factory Crimp Die is the only effective way to crimp bottleneck rifle cartridges. Our Factory Crimp Die should be used on all loads used for hunting. Applying a factory crimp will always improve the utility of the cartridge, and in most cases, will also improve the accuracy.

The Lee Factory Crimp die crimps the bullet in place more firmly than any other tool. It is impossible to buckle the case as with regular roll crimp dies. Trim length is not critical. Tests demonstrate that even bullets which have no cannelure will shoot more accurately if crimped in place with the Lee Factory Crimp Die.

Factory ammunition is often more accurate and better able to withstand rough handling because the bullet is firmly crimped in place. A firm crimp improves accuracy because pressure must build to a higher level before the bullet begins to move. This higher start pressure insures a more uniform pressure curve and less velocity variation. Even powder selection is less critical. Until now, handloaders seated the bullet to touch the rifling to achieve similar results. This is not always possible nor desirable. The Lee Factory Crimp Die is included at no extra charge with Lee 3-Die Sets and Ultimate Rifle Die Sets.

It's just another added value that only Lee Dies offer.

**LEE FACTORY CRIMP DIE
15.98**

**VERY LTD. PRODUCTION
LEE FACTORY CRIMP DIE
20.00**

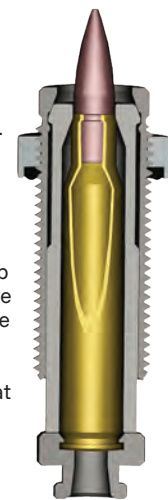

**NO CRIMP GROOVE
REQUIRED—EVEN
WITH JACKETED
BULLETS**

CARTRIDGE		CARTRIDGE		CARTRIDGE	
17 Hornet	90605	270 Win Short Mag	90962	7.7 Jap	90847
17 Remington	91571	270 Winchester	90820	25-303	91491
204 Ruger	90567	224 Valkyrie	91487	303 British	90826
22 Hornet	90829	6.8 Rem SPC	90735	32-40	91239
22 ARC	92187	7/30 Waters	90838	32 Winchester Special	91227
22 Creedmoor	92179	7 x 57 Mauser	90839	325 WSM	91255
218 Bee	90830	7 x 64 Brenneke	90821	8x56 R Hungarian	91273
221 Fireball	90829	7mm/08	90840	8x57 Mauser	90848
222 Remington	90816	7mm Express/280 Rem	90841	8mm Lebel	91272
223 Remington	90817	280 Ack. Imp.	90841	338 Winchester	90849
223 Ack. Imp.	90817	7mm Win Short Mag	91271	338 Ultra Mag	91257
25-45 Sharps	91107	7mm Rem Mag	90821	338 Weatherby RPM	92038
22/250	90818	7mm STW	90869	348 Winchester	90857
22/250 Ack. Imp.	90818	7mm Ultra Mag	90869	350 Rem Mag	91233
220 Swift	90831	284 Winchester	91249	358 Winchester	90904
243 Winchester	90819	7.35 Carcano	91269	35 Remington	90828
6mm Creedmoor	91488	7.5 x 55 Swiss	90184	35 Whelen	91241
6mm Rem /244 Rem	90832	7.5x54 French MAS	90842	9.3 x 62 Mauser	90610
243 WSSM	90187	7.62 x 39 Russian	90827	375 Ruger	90609
6mm GT	91957	7.62 x 54 Russian	90842	7mm PRC	92006
25/20 WCF	90833	300AAC Blackout	90590	300 PRC	91494
25/35	91235	300 Ham'R	91276	375 H & H	90850
250 Savage/250-3000	90834	30/40 Krag	90843	416 Remington	90906
257 Roberts	90835	30/30 Win	90822	32-20	90421
257 Ack. Imp.	90835	30/30 Ackley Improved	90822	360 Buckhammer	92035
260 Remington	90977	303 Savage	90823	38-40	90852
25/06 Rem	90836	277 Sig Fury	91990	38-55	90853
264 Win Mag	91247	308 Winchester	90823	375 Winchester	90905
26 Nosler	91163	300 Win Short Mag	90331	400 Legend	92080
6.5 Carcano	91229	300 Savage	90844	44/40	90854
6.5 x 55 Swed Mauser	90837	30/06	90824	444 Marlin	90855
6.5 Creedmoor	90704	338/06	90849	45/70 Government	90856
8.6 Blackout	91924	300 Win Mag	90825	45/70 LEVERevolution	91639
6.5 PRC	91492	300 H & H	90970	450 Bushmaster	91167
6mm ARC	91664	6.5-300 Weatherby Mag	91493	12.7x42mm fifty beowulf	91738
6.5 Grendel	90596	300 Weatherby Mag	90845	350 Legend	90445
6.8 Western	91830	300 Ultra Mag	90970	458 Socom	90815
6.5 Weatherby RPM	91822	7.65 Arg Mauser	90846	458 Win Mag	90969

Cartridge not listed? We can custom produce most cartridges factory direct if you mail in a projectile seated in an empty case to the factory. leeprecision.com/custom-factory-crimp-die

Lee Precision, Inc.
4275 County Road U
Hartford, WI 53027

LARGE CALIBER RELOADING



Accessories listed on this page compatible with Classic Cast Press, see page 21

50 BMG Loading Block

Block dimensions 9" x 8"

High impact, chemical resistant plastic

Holds 72 cases, can also be used to store 7/8 - 14 die sets

Continuous flange surrounds tray for easy lifting.

90632 15.00



1½-12 TO 1¼-12 DIE ADAPTER BUSHING

Use the Lee 50 BMG and other 1¼ series dies in competitor's 50 BMG large presses. **91697 12.00**

LARGE SERIES RELOADING DIES

1¼-12 THREAD SERIES FACTORY CRIMP DIES

50.00

- 90953 50 BMG
- 90745 338 Lapua
- 91985 404 Jeffery

1¼-12 THREAD SERIES COLLET NECKSIZING DIE

130.00

- 90747 50 BMG
- 90635 338 Lapua

1¼-12 THREAD SERIES

130.00

- 90902 577/450 Martini-Henry *
- 90929 577 Snider *
- 90252 416 Barrett *

50 BMG

170.00

SHELLHOLDER NOT INCLUDED

* THESE DIES DO NOT INCLUDE LOAD DATA



50 BMG SHELLHOLDER
90903 20.00

50 BMG RAM PRIME TOOL
90901 26.00



90515 50 BMG 3-DIE SET



LARGE SERIES THREADED DIES | Use with Classic Cast Press p. 21

CARTRIDGE	PACESETTER 2-DIE SET P 11 7/8 X 14 THREAD	CASE LENGTH GAUGE P 31-32	PRIMING TOOL SHELLHOLDER P 34	1¼-12 THREAD SERIES FACTORY CRIMP DIE	1¼-12 THREAD SERIES COLLET NECKSIZING DIES	1¼-12 THREAD SERIES FULL LENGTH SIZING DIES
338 Lapua	90353	90462	91496	90745	90635	
416 Barrett* SHELLHOLDER NOT INCLUDED						90252
404 Jeffery				91985		
577/450 Martini-Henry*						90902
577 Snider*						90929
50 BMG SHELLHOLDER NOT INCLUDED		90010		90953	90747	{90515} {\$170.00}

1½-12 to 1¼-12 DIE ADAPTER BUSHING
Use these dies in competitor's press
91697 12.00





LEE MICROMETER ADJUST SCREW



Add micrometer to any Lee bullet seating die

FEATURES:

- **Laser-engraved divisions** read to .001"—one thousandth of an inch—for unparalleled accuracy.
- **No clicks, just smooth adjustment** with the integrated friction ring. Eliminates annoying clicks that prevent splitting thousandths.
- **Economical and easy to install.** Remove adjusting screw and replace with satin smooth precision micrometer adjuster.

If you don't have Lee dies, you're in luck. We have over 175 cartridges available. Our bullet seating die with optional micrometer adjustment costs less than what others charge for their die alone!

COMPATIBLE WITH THIS STYLE BULLET SEATING PLUG

HANDGUN MICROMETER 92150 20.00

RIFLE MICROMETER 92215 20.00

LARGE CALIBER MICROMETER 92218 20.00



NOT PURCHASING LEE DIES? YOU'LL STILL NEED A SHELL HOLDER!

ALL HANDGUN AND MOST LEE RIFLE DIE SETS INCLUDE

FREE SHELL HOLDER

OTHERS CHARGE \$18.00 FOR THIS NECESSARY PART!

SET OF SHELLHOLDERS Eleven of the most popular sizes fit over 115 different cartridges.



1 · 2 · 3 · 4 · 5 · 7 · 8 · 9 · 10 · 11 · 19



UNIVERSAL SHELL HOLDER SET
90197 47.00

Works with all brands of presses

Cartridge listings are on our website. Scan this QR code to see our site.



SHELL HOLDER	FOR PRESSES 5.98	SHELL HOLDER	FOR PRESSES 5.98
#1	90518	#14	90001
#2	90519	#15	90002
#3	90520	#16	90003
#4	90521	#17	91497
#5	90522	#18	91498
#6	90523	#19	90004
#7	90524	#20	91499
#8	90525	#21	90599
#9	90526	#22	91500
#10	90527	#23	91501
#11	90528	#24	91502
#12	90529	#25	91503
#13	90199	#26	91993



Lee Resizing Lubricant

Another first by Lee! The finest automotive deep draw lubricant custom packaged exclusively for us. Lee Lube is pleasant to handle and you can thin with water. Non-sticky, non-allergenic. Very little is needed; it goes a long way. Eliminates stuck and dented cases, and makes sizing less work.

2 OZ. TUBE 90006 5.98

LEE DIE BOXES

Perfect storage for dies. Made from tough, durable plastic.

SINGLE DIE BOX	90616	2.98
ROUND DIE BOX	90535	7.50
FLAT 2-DIE BOX	91931	3.98
FLAT 3-DIE BOX	90791	4.98
FLAT 4-DIE BOX	90422	6.98

HOLDS DIES WITH BREECH LOCK QUICK CHANGE INSERT INSTALLED

LEE ULTIMATE SPLINE DRIVE LOCK RINGS



Lee Ultimate Spline Drive Lock Rings

are the perfect choice when using older style presses that require screwing your dies in and out for every operation.

The split clamp spline drive makes all other lock rings obsolete and clumsy to use. The socket head cross bolt, even when lightly tightened, applies a vise-like grip on your dies. No tiny set screws that easily strip or damage your die threads.

We added the famous Lee "O" ring because, no matter how securely you have the lock ring clamped to the die, it will loosen in the press frame during operation without the friction of the "O" ring. The "O" ring allows you to finger tighten into your press and will never loosen during operation. Kit includes a wrench for easy die removal.

Ultimate Lock Rings

90566 3 PACK WITH WRENCH 13.98

91640 4 PACK COLOR CODED 17.98

LOCK RING WRENCH SOLD SEPARATELY



Lock ring wrench sold separately

Lock Ring Wrench

A handy, compact wrench makes the new lock rings a delight to use. Spline drive lock rings are now standard equipment on all Lee dies. Update older Lee Dies or competitor's dies.

90093 3.98

STANDARD ON ALL LEE DIES

SPLINE DRIVE Lock Rings (3-Pack)

These lock rings are perfect for presses equipped with removeable die heads found on older progressive and our turret presses. Smallest outside diameter lock rings available. Captive friction "O" ring provides immovable die position with just finger tightening. Handy, no tool required for die adjustment.

90534 5.98

WORKS ON TIGHT TOOLHEADS

90093 Lock ring wrench sold separately



RELOADING PRESSES LAST A LIFETIME

so buying on what your budget allows makes the most sense. You'll never regret buying a value priced press — you'll always have a need for a simple press for miscellaneous jobs. All Lee Presses feature compound toggle linkages. This permits full length sizing the largest magnum cases with ease. Many feature built-in spent primer catchers, tough powder paint coating and detailed instructions. Under normal use, all our presses will last a lifetime.

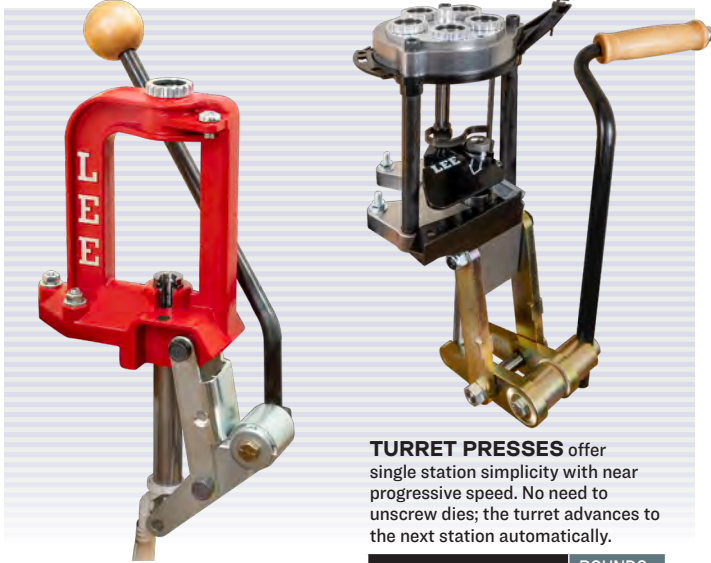

SINGLE STATION PRESSES will load nearly any cartridge. Cartridges are loaded in a batch process—for example, 20 cases are de-primed and sized, charged, then bullets seated. This die changing process is sped up by the Lee Breech Lock Quick-Change System. Rifle case reloading is best accomplished on a single station press. For a beginner, a single station press in a kit is the best value.

COMPATIBLE CARTRIDGES	ROUNDS PER HOUR
-----------------------	-----------------

All cartridges up to 460 Weatherby Mag **50**

Breech Lock Challenger III Press
90588 PG 20
\$ 120.00

Breech Lock Reloader Press
90045 PG 19
\$ 68.98

COMPATIBLE CARTRIDGES	ROUNDS PER HOUR
-----------------------	-----------------

All cartridges up to 50 BMG
Accepts both 7/8 - 14 Threaded Dies and Large Series Threaded Dies 1 1/4 - 12 **50**

Classic Cast Press # 90998
\$ 260.00
see more information page 21

TURRET PRESSES offer single station simplicity with near progressive speed. No need to unscrew dies; the turret advances to the next station automatically.

COMPATIBLE CARTRIDGES	ROUNDS PER HOUR
-----------------------	-----------------

All cartridges up to 460 Weatherby Mag **250**

Four pulls of the lever and you have a completed round. Perfect for moderate production of handgun ammunition. Deactivate the Auto-Index feature and you can batch reload the longest rifle cartridges. Snap in a new shell holder, and you're ready to load your next cartridge.

Classic Turret Press
4 STATIONS
90064 PG 23 **\$260.00** TWIST AND EXCHANGE THE TURRET TO CHANGE CARTRIDGES

Value Turret Press
4 STATIONS
90932 PG 24 **\$175.00**

ULTIMATE TURRET PRESS gives the operator control over the number of strokes to a completed round: 3, 4, 5 or 6.

Press ships with 5 or 6 station tool carrier— room for you to install our accessory Inline Bullet Feed die for hand-free bullet feeding. Safety Prime included for dispensing any brand or size of primer. Case ejector whisks away finished round to the included ammo bin. Each die position is quick change, simply twist a 1/8 of a turn to remove dies, and store them in fitted die box, keeps your adjustment settings. Snap in a new shell holder, and you're ready to reload the next cartridge.

Ultimate Turret Press PG 22
3, 4 and 6 positions also available with accessory tool carrier and index rod.
\$320.00

SINGLE STAGE PRESS KIT OPTIONS

if just getting started, you'll save even more by purchasing a kit

Hand Loader Kits in popular cartridges
PAGE 19 **\$99.98**



50th Anniversary Kit
90050 page 20 **\$229.00**



Challenger Kit 90030 page 20 **\$259.00**

TURRET PRESS KIT OPTIONS



Ultimate Turret Press Kit
available in popular cartridges
page 22
\$420.00

Classic Turret Press Kit
90304 page 23
\$399.00



PROGRESSIVE PRESS OPTIONS



PRO 1000

PRO 4000

SIX PACK PRO

PRO 1000 Time proven design updated with rock solid tool head with Smart Lock quick change bushings. Improved tray fed primer feed, simple, reliable and safe with any brand primer. Simplified automatic indexing with no adjustments required. Add a bullet and pull the lever; other operations are automatic. Includes 4 tube automatic case feeder, automatic primer feed, automatic powder measure and automatic indexing. No other press has all these features at this affordable price. The perfect press for the active shooter on a budget. Select this press if you have a good supply of quality fired cases.

PRO 4000 This 4 station progressive press allows reloading mixed range brass with ease. The user operated primer feed allows smooth uninterrupted operation when loading mixed and imperfect cases. The fourth station allows installation of the Lee Factory crimp die. This die “irons out” the defects and damage found in mixed range brass. If you have select components to reload, the extra station can be fitted with the New Inline Bullet Feeder. Push the primer trigger, pull the lever, and you’re loading. Easy cartridge changeover with only die adjustments required.

SIX PACK PRO Among the heaviest progressive presses made. Stroke and powerful linkage easily reload longer rifle cartridges. Six stations allow for any brand of die use; extra operations like post sizing are done in the standard progression. Works great with inline bullet feeders; extra stations allow seating and crimping to be separate operations. Simple, dependable automatic indexing never requires adjustment. New primer feed device built-in; takes just seconds to change primer size. Primer feed tray eliminates the danger and time-consuming process of filling primer tubes one at a time. With the Lee system— just dump, shake and go. Only one tool required to change shell plates (it’s included!) Included loaded round catcher and attach bracket features storage positions for shell plate and die wrenches. Universal case feeder included with a gatling style magazine that works with most handgun cases and shorter rifle cases.

COMPATIBLE CARTRIDGES	ROUNDS PER HOUR
32 S&W Long to 223 Remington	500+
Pro 1000	
Full description PG 25	
\$ 300.00	

COMPATIBLE CARTRIDGES	ROUNDS PER HOUR
32 S&W Long to 30/06	500+
Pro 4000 Kit	
Full description PG 26 \$ 355.00	
Auto Breech Lock Pro	
Press only # 90900 PG 26 \$ 210.00	

COMPATIBLE CARTRIDGES	ROUNDS PER HOUR
32 S&W Long to Large Magnum Rifles	500+
Six Pack Pro Kit	
Full description PG 27 \$ 560.00	
Pro 6000 Six Pack Reloading Press	
Press only # 91823 PG 27 \$ 400.00	

COMPACT PRESSES

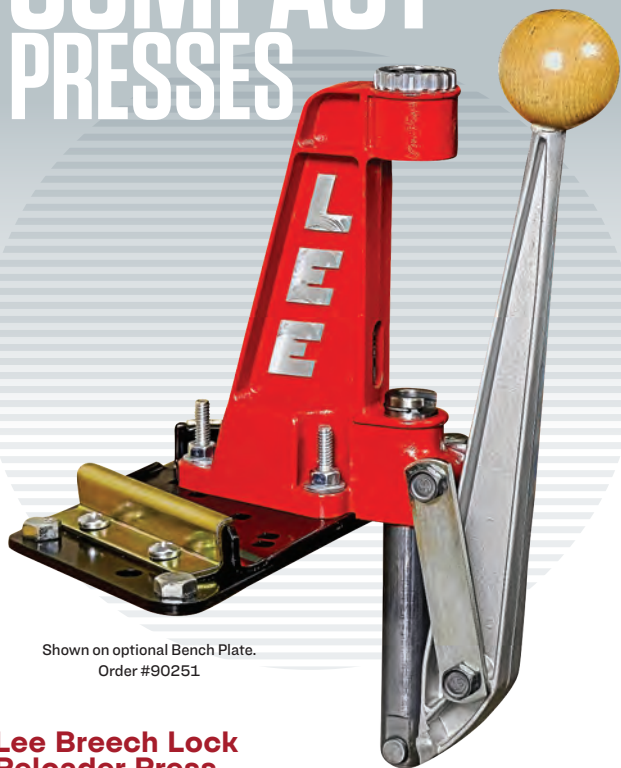

Shown on optional Bench Plate.
Order #90251

Lee Breech Lock Reloader Press

INCLUDES THE BREECH LOCK SYSTEM

An outstanding value. Exclusive balanced lever that can't drop down to pinch your fingers. Unlimited hand clearance that only a "C" frame can offer. Works equally well with the right or left hand. Even if you already own a press, an extra press is always useful for decapping, bullet seating or bullet sizing.

90045 68.98

Change dies instantly
WITH A TWIST
OF THE WRIST

SPLINE DRIVE BUSHINGS

Breech lock quick change bushing with integral lock collar provides unmatched precision and convenience when adjusting dies. Split clamp positively locks die into position.

90063 2-PK 16.00



Buy more for greater savings



90095 4-PK 27.00



SMART LOCK BUSHINGS

Standard on Breech Lock Die Sets
No tool die adjustments needed.

91933 4-PK 27.00

COLOR CODED FOR QUICK,
POSITIVE DIE SELECTION

BREECH LOCK BUSHINGS
Breech lock bushings fit all Lee Breech Lock presses. Allows instant, accurate die changes.

90600
2-PK. 16.00



Lee Breech Lock Hand Press

Features the Lee Breech Lock System. A full size hand held reloading press, yet the tool weighs only 1¾ pounds and costs so little you will want more than one. No matter how much equipment you have, it's great to have a portable hand press. No time is wasted mounting a tool to a work bench. When you're finished—just pack it away in its molded storage box.

90685 74.00



NEW
storage
box



MOLDED STORAGE BOX ONLY
92095 12.00

Hand Loader Kit

EVERYTHING YOU NEED TO START RELOADING

THE PERFECT PORTABLE RELOADING PRESS KIT

Unlock your reloading potential—anywhere, anytime! No wasted time mounting to a workbench. Pack it in the molded storage box when finished. Don't let limited space hold you back. With our compact and portable solution, you can enjoy the freedom of reloading wherever you are. Hand Loader Kit includes: Breech Lock Hand Press, Breech Lock Reloading dies, Breech Lock Ram Prime. Select from popular cartridges below. \$166.98 value if purchased separately.

KIT INCLUDES:

- BREECH LOCK HAND PRESS
- BREECH LOCK RAM PRIME
- BREECH LOCK 3-DIE RELOADING SET

NEW



99.98

- | | |
|-------------------------|-------|
| 9MM LUGER | 92114 |
| 38 SPECIAL 357 MAGNUM | 92115 |
| 45 ACP | 92117 |
| 223 REMINGTON | 92118 |

Breech Lock Ram Prime

Start priming in seconds, nothing to adjust.

Includes small and large priming assemblies, no tiny parts to fumble with or lose.

Effortless priming in the tightest pockets.

Uses any brand press shell holder.

Safe with all brands of primers.

Works in any Lee Breech Lock press or adapter.

91612 21.98

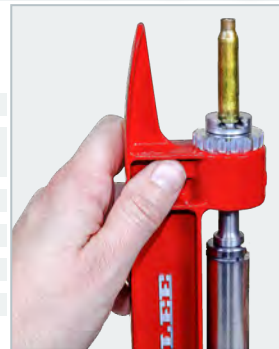

BREECH LOCK RAM PRIME

Lee Ram Prime (for old school presses where you thread dies in and out)

Primes on the press up-stroke for a more sensitive feel. Includes small and large priming assemblies; no tiny parts to fumble or lose. Fits all brands of old school presses, where you need to thread dies in and out.

90106 21.98



CHALLENGER III

"O" FRAME
MOST POPULAR
STYLE PRESS
BY FAR

BREECH LOCK Challenger III PRESS

Challenger III celebrating forty years!

Third generation Challenger features everything that made the Challenger the world's bestselling single station press. Plus, we have added an ergonomically formed lever allowing even more comfortable operation with no more stooping at the bottom of stroke. Spent primers fall through the ram and collect in a convenient tube. Keeps dirt and grime off the frame and ram, and your workspace clean. Priming position is moved up front where the action is, and the LEE LEVER PRIME SYSTEM is still instant change with no tools. Say goodbye to time-consuming die adjustments, BREECH LOCK QUICK CHANGE DIE SYSTEM is built in. Change dies instantly with a twist of the wrist; you'll never have to re-adjust your die. Works with all brands of dies; same unbreakable "O" frame design, all steel linkage, and adjustable length lever. This same press would cost you more than twice as much from other manufacturers, and that's without all of the Challenger's features.

90588 120.00

LARGE & SMALL
SAFETY PRIME
90997 30.00
SEE DESCRIPTION PAGE 24



Shown on optional Bench Plate. Order #90251

50TH ANNIVERSARY KIT

A COMPLETE POWDER HANDLING SYSTEM WITH THE MOST CONVENIENT AND REPEATABLE PERFECT POWDER MEASURE, PLUS THE LEE SAFETY SCALE, THE MOST SENSITIVE, SAFEST OF ALL POWDER SCALES. FILL YOUR CASES WITH THE POWDER FUNNEL.

Case Preparation tools include the LEE VALUE TRIM case trimmer to trim on your reloading press (order cartridge specific trim die separately on pg. 31-32), and a CUTTER & LOCK STUD to trim your cases. (Order cartridge specific case length gauge separately on pg. 31-32). The LEE CHAMFER TOOL chamfers the inside and outside of the case mouth, and a tube of premium SIZING LUBE is also included. A small and large PRIMER POCKET CLEANING TOOL completes the case preparation package.

But that's not all! You get the large and small SAFETY PRIME. Prime with push button convenience and is safe with all brands of primers. Never touch the primer from box to the case.

Purchased separately \$272.86 value 90050 229.00

40TH ANNIVERSARY PACK



Purchase Challenger and get a FREE set of Breech Lock Reloading dies, select from popular cartridges below. This package is just as complete as the original Lee Loader, in that all you need are powder, bullet and primers. \$179.00 retail value (\$120.00 Challenger Press + \$59.00 Breech Lock Die Set).

120.00

- 9mm Luger 92134
- 38 Spl | 357 Mag 92130
- 44 Spl | 44 Mag 92133
- 45 ACP 92135
- 223 Rem 92139



CHALLENGER KIT

Featuring all of the components of the 50th Anniversary Kit, but we've replaced the Safety Prime with the Auto Bench Prime, 3 of the most popular Auto-Prime shell holders which work with over 60 different cartridges, and our power grip shell holder for case prep. This kit is ideal for those who want to prime on the workbench.

Purchased separately \$309.78 value 90030 259.00

Shown on optional Bench Plate. Order #90251

Have an old school press and thread dies into removable, threaded adapter? Modernize your press with the **Breech Lock system**
90512 1¼-12 16.00
90094 1½-12 17.00



PRESS NOW INCLUDES BREECH LOCK ADAPTER

Gives you the ability to quick change dies or remove the adapter to load the mammoth 50 BMG

BAKED POWDER FINISH AND ALL STEEL LINKAGE MAKE THE LEE CLASSIC CAST PRESS THE MOST ATTRACTIVE AND DURABLE PRESS MADE

RIGID CAST IRON FRAME, CAST & MACHINED WITH PRIDE IN THE USA

LEE CLASSIC CAST PRESS
90998 260.00

- ▶ The industry's largest opening, and longest stroke—handle adjusts to provide least travel of any press.
- ▶ Largest ram, 1½" diameter, supported by over 12 square inches of ram bearing surface.
- ▶ Spent primer disposal direct to trash can with attached tube.
- ▶ Powerful compound linkage with positive travel stop prevents press toggle or "cam over."
- ▶ Rigid cast iron construction in a classic "O" design for maximum strength. Baked powder coating is durable and makes a handsome addition to any reloading bench.
- ▶ Large, flat cored base with 3 mounting holes, mounts solid to any bench.
- ▶ Automatic primer arms with bottom of stroke priming for best feel. Includes both large and small priming arms. No more fumbling with tiny guides and springs when changing primer size.

Shown on optional Bench Plate. Order #90251

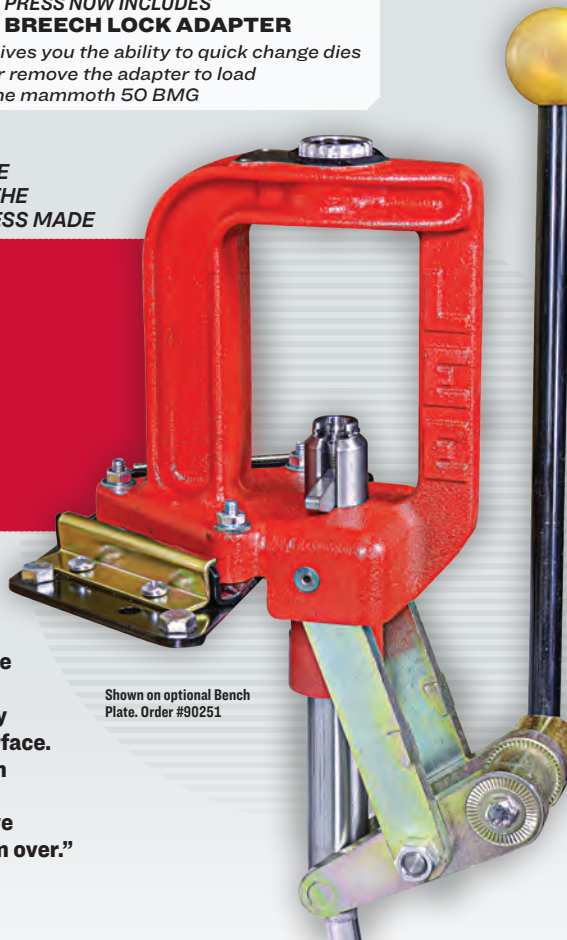

▶ **LARGE & SMALL SAFETY PRIME**
90997 30.00



▶ **CHANGES EASILY FOR LEFT-HANDED USE.**

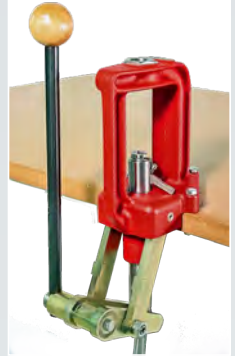

▶ **SPENT PRIMERS COLLECTED AND DROPPED INTO FLEXIBLE PLASTIC TUBE FOR EASY EMPTYING.**



- ▶ Designed to work with both standard 7/8-14 and large series 1¼-12 dies. Included Breech Lock adapter to accept standard 7/8-14 dies. Change dies instantly with a quick twist of the wrist.
- ▶ Two-piece ram allows installation of the mammoth 50 BMG shell holder or the shell holder insert for standard press shell holders. Shell holder insert can be rotated to allow primer installation on the right or left side.

CLASSIC CAST 50 BMG PRESS KIT

AT LAST, AN AFFORDABLE WAY TO RELOAD THE MONSTER 50BMG

KIT INCLUDES EVERYTHING YOU NEED TO START RELOADING THE 50

LEE CLASSIC CAST PRESS • 50 BMG 3-DIE SET
SHELL HOLDER • RAM PRIME TOOL • AND TUBE
OF CASE SIZING LUBE

BREECH LOCK ADAPTER KIT also includes shell holder insert, large & small primer arms and breech lock adapter bushing to accept standard 7/8-14 dies so you can load all your smaller cartridges. All this for less than what others charge for dies alone.

50 CALIBER BMG PRESS KIT
90859 425.00



Upgrade Your Reloading Experience with the Lee Ultimate Turret Press

THE PINNACLE of reloading convenience and precision — the Lee Ultimate Turret Press. Built upon the legacy of the Classic model, this next-generation press boasts a host of enhancements and innovative features designed to elevate your reloading experience.

Enjoy effortless operation with the powerful Big Press linkage, providing smooth and reliable performance with every stroke. Experience unparalleled stability and accuracy with circumferential tool head support, setting the Ultimate apart from the rest.

Say goodbye to cumbersome die changes — the five-hole tool carrier, coupled with Lee's BREECH LOCK SYSTEM — enables quick die changes without losing your settings, saving you valuable time and effort.

Automatic advancement of the tool carrier with each downstroke, combined with the new indestructible index mechanism, ensures reliability and longevity, so you can reload with confidence for years to come. Plus, the addition of a case ejector eliminates manual handling, allowing you to focus on what matters — producing flawless rounds with precision and efficiency.

Crafted for comfort and durability, the Ultimate features an ergonomic design with a formed lever and roller handle, ensuring a smooth and comfortable reloading experience every time. And with the included tool rack, keeping your essential accessories organized and within reach has never been easier.



ULTIMATE PRESS KIT 420.00

- I N C L U D E S
- ULTIMATE TURRET PRESS • SAFETY PRIME
 - DELUXE AUTO DRUM POWDER MEASURE • SAFETY SCALE
 - INLINE BULLET FEED MAGAZINE TUBES • AMMO BIN
- CONSIDER COMPLETING KIT WITH THE INLINE DIE ONLY (SEE LISTING ON PAGE 28)

5 Station Kits

- Nº 91923 223 Rem
- Nº 92172 9mm Luger
- Nº 92173 38 Special | 357 Magnum
- Nº 92175 45 ACP

6 Station Kits

- Nº 92098 223 Rem
- Nº 92099 9mm Luger
- Nº 92100 38 Special | 357 Magnum
- Nº 92101 45 ACP



Powerful compound linkage

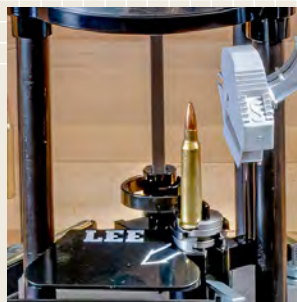

Automatic case ejector



Automatic advancement of the tool carrier

◀ PRESS ONLY 320.00

- INCLUDES
- ULTIMATE TURRET PRESS
 - SAFETY PRIME
 - AMMO BIN
- 5 station Nº 91910
6 station Nº 92097

INTERCHANGEABLE TOOL CARRIERS

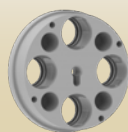

4 HOLE Nº 92088 30.00

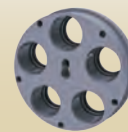

5 HOLE Nº 92177 30.00



3 & 6 HOLE Nº 92087 35.00

Lee Classic Turret Press

THE STURDY IRON BASE shows its Classic Cast roots. The long stroke allows rifle cases over three inches long to be loaded using the automatic index. Deactivate the Auto-Index and cases over 4 inches can be loaded. The rigid cast iron frame supports the ram with over 12 square inches of area. The industry's largest ram is drilled completely through to dispose primers in an attached clear PVC tube. Every primer is caught — guaranteed.

Instant change turrets are the same as the famous Lee Turret Press. The Classic Turret uses the LEE LEVER PRIME SYSTEM · LPS and optional Lee Safety Prime tool makes priming on the press a delight. If you like to own the best—treat yourself to the Lee Classic Turret. The finest reloading system made.

LEE CLASSIC TURRET PRESS 90064 260.00

*a machine
that
does it all*

This press has all the features of the award-winning Turret Press with the quality touches that make this the finest, most convenient press to own.

The Classic Turret features the solid steel linkage of the Lee Classic Cast. Your first stroke of the hardwood gripped lever will convince you this is one solid, silky smooth press!



LEE SAFETY PRIME

Makes priming on the press a delight. Never touch the primers from box to shell. Primer flip tray features a CAD designed flipping surface that instantly rights the primers. Change primer size in seconds. Primers are dispensed with a satisfying click of the primer feed trigger.

90997 30.00



ROLLER HANDLE UPGRADE KIT
92040
40.00

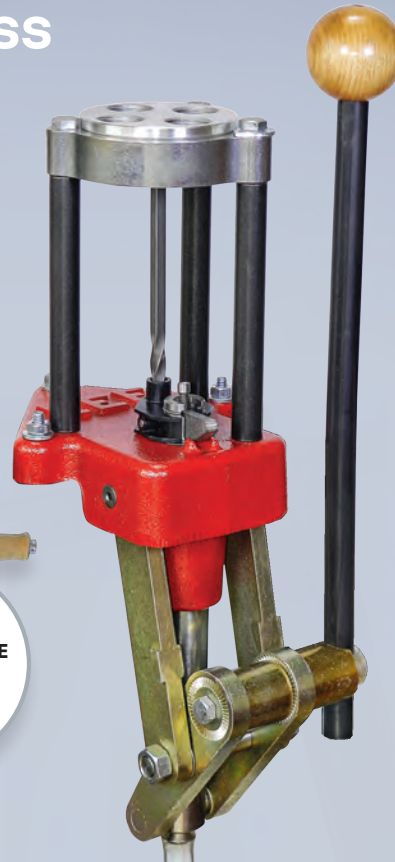

SPENT PRIMERS COLLECTED AND DROPPED INTO FLEXIBLE PLASTIC TUBE FOR EASY EMPTYING.

Shown on optional Reloading Stand. Order #90688



POWDER MEASURE RISER FOR SAFETY PRIME
90041
See page 36



GET AN ADDITIONAL TURRET FOR YOUR LEE PRESSES
EXTRA TURRET, 4 HOLE
90269 15.00

CLASSIC TURRET PRESS KIT

This kit and a set of Lee dies is everything you need to begin reloading pistol ammo. The Classic Turret Press is fast and convenient when loading handgun cartridges, with rates in excess of 250 rounds per hour possible.

The kit includes the DELUXE AUTO DRUM POWDER MEASURE, perfect for all handgun and rifle cartridges. Large and Small SAFETY PRIME are included making on press priming a delight! Instant Change Turret makes changing calibers a snap. Deactivate the auto-index, and batch load the longest and largest rifle cartridges.

Complementing your press kit are the case conditioning tools to prepare your brass for loading. Includes CUTTER, LOCK STUD, CHAMFER TOOL, small and large PRIMER POCKET CLEANER, and a tube of LEE CASE SIZING LUBE. Complete it with the cartridge specific CASE LENGTH GAUGE. Verify your loads with the included LEE SAFETY POWDER SCALE.

Completing the kit is MODERN RELOADING SECOND EDITION, 2023 revision with all new load data covering over 170 cartridges with more than 38,000 loads.

90304 399.00



Shown on optional Bench Plate. Order #90251

NOTE Rifle reloaders require SHORT or LONG CHARGING ADAPTER | see page 36

VALUE TURRET PRESS

EQUIPPED WITH THE **LEE LEVER PRIME SYSTEM™**



Shown on optional Reloading Stand. Order #90688

Low profile steel base with positive through ram primer disposal

Proven design with compound leverage. No spring in this turret design. The turret is locked into a solid steel ring with big rifle bolt type lugs. Exclusive design puts the lugs on the circumference so there can be no tipping. The linkage is so powerful that the largest magnum cases are sized with ease. Effort required is so small that the usual heavy bench is not essential. The Lee Turret Press has built-in primer disposal tube and a comfortable roller handle. Even if you do not need all of these features, why pay more for anything less?

Power and strength to spare, plus unequalled convenience. The Lee Turret Press is suitable for loading short rifle and pistol cases, but really shines when loading large quantities of handgun ammunition. This is the most convenient press made. Only a true progressive press is faster. Includes the **LEE LEVER PRIME SYSTEM** with large and small primer arms. Works with the **LEE SAFETY PRIME**.

4 HOLE TURRET PRESS W/AUTO INDEX

90932

175.00

Built-in primer disposal tube ▶



GET AN ADDITIONAL TURRET TO KEEP YOUR DIES ADJUSTED IN POSITION. SWAP CARTRIDGES BY SIMPLY INSTALLING NEW TURRET

EXTRA TURRET, 4 HOLE
90269 15.00

Lee Safety Prime

Makes priming on the press a delight. Never touch the primers from box to shell. Primer flip tray features a CAD designed flipping surface that instantly rights the primers. Change primer size in seconds. Primers are dispensed with a satisfying click of the primer feed trigger. Allows safe dispensing of any brand and size of primer.

90997 30.00



POWDER MEASURE RISER FOR SAFETY PRIME

installs between the lee powder through expanding or charging die and Auto Drum or Pro Auto Disk powder measure. Provides clearance for the Lee safety prime on turret presses

90041 9.98



LEE PRO 1000

INTRODUCED IN 1984 AS THE WORLD'S FIRST AFFORDABLE PROGRESSIVE PRESS.

Place a bullet and pull the lever; all other operations are automatic. Load singly or progressively, feeds powder and primers only if case is present.

Rock solid tool head with smart lock quick change bushings. Cartridge changeover in seconds. Automatic primer feed simple and reliable; safe with any brand or size of primer.



Ergonomic wood grip AND all-steel linkage

◀ Built-in primer disposal tube

Press mounted to optional Reloading Stand #90688 pg. 4

38 SPECIAL AND 357 MAGNUM	90636
9MM LUGER	90640
40 S&W	90682
44 SPECIAL AND 44 MAGNUM	90634
45 ACP	90638
45 COLT	90643
223	90633
INCLUDES SHORT CHARGING ADAPTER	

LEE PRO 1000 COMPLETE, READY TO RELOAD 300.00

PRO1000 POSITIVE INDEX SHELL PLATES 20.00

PRODUCT NO.	PLATE	CARTRIDGES
90651	1S	38 SPECIAL, 357 MAG, ETC.
90652	2L	45 ACP, 45 GAP, ETC.
90664	3L	45 WINCHESTER MAGNUM
90653	4S	222, 223, 300 ACC BLACKOUT 380 AUTO
91833	4AS	32 S&W Long, 32 H&R MagNUM
90655	7S	30 M1 CARBINE, 32 AUTO
90657	11L	44 SPECIAL, 44 MAGNUM, 45 COLT
90666	12L	7.62X39, PPC, 220 RUSSIAN
90065	14L	38/40, 44/40, 45 COLT, 460 S&W
90669	19	40 S&W, 10 MM AUTO, 9MM LUGER, 38 SUPER, 38 AUTO, 41 AE



4-TUBE CASE COLLATOR

Fill all four tubes in just 10 seconds. Works with handgun, .380 to 45 Colt.

90667 14.98

ACCESSORIES FOR PRO 1000 • PRO 4000 • SIX PACK PRO

UNIVERSAL CASE FEED MAGAZINE

92044 **40.00**
Automates case feeding process. Cartridge compatibility listing on leeprecision.com

EXTRA CASE FEEDER TUBES

7 Pk. 90661 **12.98**



FOLDING PRIMER TRAY 2-PK

90606 **9.00**

UNIVERSAL 5-TUBE CASE COLLATOR

Fill all five tubes in just 10 seconds. Works with handgun and rifle.

92059 20.00



PRO 4000 KIT

S ECOND-GENERATION progressive press priced less than many premium single station presses, the lowest priced four-station progressive available. It is also the easiest to use progressive press ever made. Everything included to begin reloading nothing else to buy.

All the features of the Pro 1000 with an added fourth station to allow factory crimping and post sizing.

Features a fixed tool head with quick-change bushings. The Safety Prime is safe with all brands of primers and makes on press priming fast and dependable. The ideal press for loading well used or mixed range brass. So easy to change you're going to enjoy using this press for simple case preparation, like depriming before tumble cleaning. Deactivate the auto index and it is the handiest single station press ever made.

ACCESSORY
CASE COLLATOR
92059 20.00



LEE PRO 4000 KIT

ADJUST YOUR DIES AND BEGIN RELOADING
355.00

Includes storage rack for tools, and hex wrench for shell plate changeover. Others charge nearly \$30 for this feature.

Ergonomic wood grip roller handle. Others charge nearly \$50.00 for this feature. Bin & Bracket to catch loaded rounds.

Auto Breech Lock Pro Press	210
Large & Small Safety Prime	30
Auto Drum Powder Measure	55
Shell Plate	25
Universal 5 Tube Case Feeder	40
Reloading Dies	49
Bin & Bracket	14
Color Coded Smart Lock Bushings	27

PURCHASED SEPARATELY, VALUED OVER
\$450

AUTO BREECH LOCK PRO Press only #90900 **210.00**

45 ACP	91550
9mm LUGER	91555
38 SPECIAL AND 357 MAGNUM	91557
44 SPECIAL AND 44 MAGNUM	91558
223 REMINGTON	91551

AUTOMATICALLY ADVANCES CASES UP TO 2 5/16" LONGER CARTRIDGES CAN BE LOADED BY MANUALLY ADVANCING.

AUTOMATIC UNIVERSAL CASE FEED MAGAZINE

MODULAR CONSTRUCTION ALLOWS AS MUCH OR AS LITTLE AUTOMATION AS THE OPERATOR DESIRES WITH NO ADJUSTMENTS.

CARTRIDGE CHANGEOVER IN SECONDS, INCLUDING PRIMER SIZE WITH NO ADJUSTMENTS. COLOR CODED SMART LOCK QUICK CHANGE BUSHINGS.

INCLUDES LARGE AND SMALL SAFETY PRIME AND PRIMING ARMS. SAFELY DISPENSES ANY BRAND OF PRIMER.

PRO 4000 SHELL PLATES 25.00

PRODUCT NO.	PLATE	CARTRIDGES
90582	1	38 SPECIAL, 357 MAG, ETC.
90584	2	45 ACP, 45 GAP, 6,5 CREEDMOOR.
90629	3	45 WINCHESTER MAGNUM
90630	4	222, 223, 380 AUTO, 32 S&W LONG, 32 H&R MAG, 300 AAC BLACKOUT
90647	7	30 M1 CARBINE, 32 AUTO
90278	9	41 MAGNUM
90648	11	44 SPECIAL, 44 MAGNUM, 45 COLT
90414	12	7.62 x 39 RUSSIAN, 6.5 GRENDSEL
90649	13	45 AUTO RIM
90802	14	38/40, 44/40, 45 COLT, 460 S&W
90659	16	500 S&W, 7.62X54R
90944	19	40 S&W, 10MM AUTO, 9MM LUGER, 38 SUPER, 38 AUTO, 41 AE
90941	21	6.8 SPC, 224 VALKYRIE



Press mounted to optional Reloading Stand #90688 pg. 4

COLOR CODED FOR QUICK, POSITIVE DIE SELECTION



SMART LOCK BUSHINGS
91933 4-PACK 27.00



ACCESSORY
CASE COLLATOR
92059 20.00

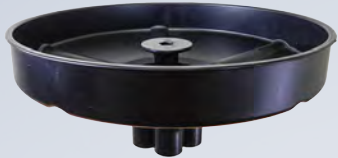

Case sensor only feeds primer if case is present.
No more swapping the retainer ring when changing cartridges.



SIX PACK PRO KIT

ULTIMATE FLEXIBILITY & PROGRESSIVE SPEED

HEAVY DUTY STEEL CONSTRUCTION, stroke and clearance sufficient for the largest magnum rifle cases. Indexing is simple and reliable, cases fed and primed automatically with no primer brand restriction. Carrier features easy-to-set case retainers at every station. All dies securely fastened in the upper die carrier with the quick change LEE BREECH LOCK SYSTEM. Six stations gives you additional space to mount accessories. Automatic case ejector whisks completed rounds to the ammo bin.



INLINE BULLET FEEDER
SEE PAGE 28 FOR ALL THE OPTIONS



- SIX STATIONS ALLOW ANY BRAND OF DIE USE
- SIMPLE, RELIABLE AUTOMATIC INDEXING
- STROKE AND CLEARANCE SUFFICIENT FOR LARGEST MAGNUM RIFLE CASES
- MASSIVE 28.4MM RAM GLIDES THROUGH 82MM OF SOLID STEEL, GIVES RAM OVER 7300 MM² OF SOLID SUPPORT
- DIES SECURELY FASTENED IN UPPER DIE CARRIER WITH SMART LOCK BUSHINGS
- AUTOMATIC PRIMING SYSTEM – SIMPLE, RELIABLE AND SAFE WITH ANY BRAND OR SIZE OF PRIMER
- AUTOMATIC CASE INSERTER WORKS WITH ANY CASE
- EASY TO SET CASE RETAINERS ON EVERY STATION
- AUTOMATIC CASE EJECTOR WHISKS COMPLETED ROUNDS INTO AMMO BIN

SIX PACK PRO INCLUDES SIX PACK RELOADING PRESS • DELUXE
AUTO DRUM POWDER MEASURE • APPROPRIATE SHELL PLATE
UNIVERSAL CASE FEED MAGAZINE & LEE BREECH LOCK DIES • AMMO BIN
AVAILABLE IN POPULAR CALIBERS \$560.00

- | | |
|------------------|-------|
| 223 REMINGTON | 91899 |
| 300 AAC BLACKOUT | 91918 |
| 6.5 CREEDMOOR | 91919 |
| 32 S&W LONG | 91900 |
| 9MM LUGER | 91901 |
| 380 AUTO | 91902 |
| 38 SPECIAL | 91903 |
| 40 S&W | 91904 |
| 44 SPECIAL | 91905 |
| 45 ACP | 91906 |
| 45 COLT | 91907 |



SIX PACK PRO RELOADING PRESS ONLY
PRODUCT NO. 91823 | \$400.00



SMART LOCK BUSHINGS
91933 4-PACK 27.00

COLOR CODED FOR QUICK, POSITIVE DIE SELECTION



SIX PACK PRO SHELL PLATES 35.00		
PRODUCT NO.	PLATE	CARTRIDGES
91835	1S	38 SPECIAL, 357 MAG, ETC.
91836	2L	45 ACP, 30/06, 308, 6.5 CREEDMOOR
91837	3L	30/30, 7x30 WATERS, 7.5 SWISS
91838	4S	222, 223, 380 ACP
91839	4A	32 S&W LONG, 32 H&R MAG., ETC
91840	5L	BELTED MAGNUMS 300 MAG 303 BRITISH, 30/40 Krag, 7MM WSM
91841	6S	32/20, 25/20, ETC.
91842	7S	30 M1 CARBINE, 32 ACP
91843	8L	45/70, 348 WIN, 416 RIGBY
91844	9L	41 MAGNUM
91845	10L	220 SWIFT, 6.5 JAP
91846	11L	44 MAG., 44 SPL., 45 COLT
91847	12L	7.62X39, 6MM PPC, 22 PPC, ETC.
91848	14L	44/40, 38/40, 45 COLT, 460 S&W
91849	15S	5.7 X 28 FN
91850	16L	500 S&W, 7.62 X 54R
91851	19S	9MM LUGER, 40 S&W, 38 SUPER, ETC.
91852	19L	10MM AUTO
91853	20	22 HORNET
91854	21L	6.8 REM SPC

ROLLER HANDLE UPGRADE KIT
92040
40.00

INLINE BULLET FEEDER

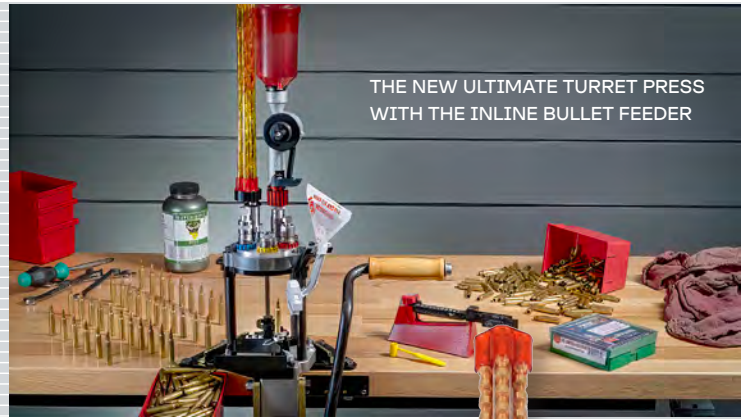

THE NEW ULTIMATE TURRET PRESS WITH THE INLINE BULLET FEEDER



Shown with optional gatling style magazine

All steel construction featuring a ball bearing escapement mechanism.

Spring loaded positive ball carrier return assures reliable operation.

Jacketed, cast, powder coated and copper plated bullets are reliably fed. Configurable for long and short bullet lengths.

Includes bracket for the optional multi-tube feed magazine. Works in any press with standard 7/8-14 threads.

Each die is caliber specific so there is nothing to change or adjust.

Easy adjustment — place a case in your press and screw the Inline Die in until it drops a bullet — plus a half a turn, and that's it!

INLINE BULLET FEED KIT

70.00
Includes Inline die and appropriate multi tube feed magazine



INLINE DIE ONLY \$50.00	CALIBER	TYPICAL	BULLET DIAMETER RANGE	INLINE BULLET FEED KIT \$70.00	REPLACEMENT BALLS \$5.00
91998	22 CAL	22 Hornet to 222 Rem Mag	.220 — .225	92010	92002
92025	24 CAL	6mm to 243	.238 — .245	92026	92060
92000	26 CAL	6.5 Creedmoor & similar	.250 — .273	92012	92061
92214	28 CAL	270 Win to 7mm Rem Mag	.277 — .284	N/A	92061
91999	30 CAL	30 M1 to 30/06	.300 — .320	92011	92061
91995	35 CAL	380 Auto to 357 Mag	.312 — .360	92007	92062
91996	40 CAL	40 S&W	.390 — .406	92008	92063
92071	44 CAL	44 Mag & 44 Spl	.425 — .435	92072	92063
91997	45 CAL	45 ACP to 45 Colt	.435 — .460	92009	92064

PURCHASE EXTRAS FOR QUICK MAGAZINE SETUP

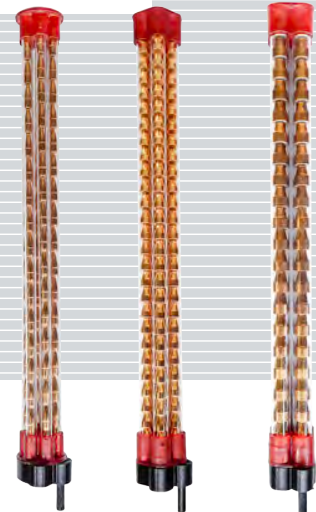

SMALL # 92014 \$30.00 Works with .220 to .273 diameter bullets.	MEDIUM # 92015 \$30.00 Works with .300 to .372 diameter bullets.	LARGE # 92016 \$30.00 Works with .395 to .463 diameter bullets.
--	---	--

ALL THREE JUST \$60.00
92013

Inline Bullet Sizer Magazine Filler Kit

Kit contains everything you need to use the Bullet sizer and punch with the LEE **INLINE BULLET FEED MAGAZINE**. Now you can size bullets and simultaneously fill the Lee Gatling style magazine feeder. The system works so well—once your bullet is sized you will never touch it again. Simply transfer filled magazine to press and start loading. Includes small, medium & large magazines with matching drop tubes and supports, Breech Lock bullet sizer and special adapter. Works with .220 to .463 diameter bullets. See page 38 to order bullet sizers and punches. Use the QR code to see expanded list of sizes.

INLINE BULLET SIZER MAGAZINE FILLER KIT
92019 **65.00**

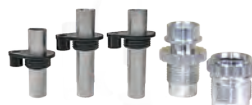

RELOADER PRESS shown with Inline Bullet Sizer Magazine Filler Kit

**WORK SMARTER,
NOT HARDER**

AUTOMATIC **P**ROCESSING **P**RESS

NOTHING MAKES RELOADING MORE ENJOYABLE than clean and properly processed and prepared brass. The APP series takes the drudgery out of case preparation.

This is the first choice for the bullet caster or progressive high volume reloader. Size bullets, swage primer pockets, size and deprime cases at lightning speed. The APP is a frameless design giving you nearly unlimited visibility and hand clearance. The powerful compound toggle linkage operates with ease. The compact footprint mounts easily on any bench or table top with no lever under swing. Counter balanced lever prevents the handle from falling and pinching a finger. Integral single tube case and bullet feeder makes the APP the fastest single station press made. Accepts standard 7/8-14 dies and shell holders of any manufacture.

APP PRESS 90933 **115.00**

INCLUDES PRESS, CASE/BULLET FEEDER, SHELL HOLDER ADAPTER AND CASE/BULLET FEED TUBE BOTTLE ADAPTER

FOR AUTOMATIC CASE SIZING AND DEPRIMING BE SURE TO ORDER **X-PRESS SHELL HOLDER** FOR YOUR CARTRIDGE

APP shown on optional Reloading Stand #90688 with Inline Bullet Sizer Magazine Filler Kit # 92019 and Inverted Size & Fill adapter # 92022 installed.



DELUXE **A**UTOMATIC **P**ROCESSING **P**RESS KIT

GIVES YOU THE SAME priming convenience found only on expensive progressive reloading presses.

We started with the basic APP, added the Roller Handle, Universal Case Feed Magazine and the APP Deprime kit. Then we fitted the tool with the Patented automatic primer feed system. There is no priming system made that is as fast, effortless, or uniform as the APP primer.

Cases and primers are automatically fed. Primers are seated uniformly without “feel” or adjustments required. Safe with any brand or size of primer.

Change primer size in seconds. Simply twist out the priming chamber and swap out the pin and primer guide. No shell holders required!

When you’re finished priming — simply twist out the priming tool and replace with the supplied shell holder adapter. Then you can use all the APP accessories available to Bulge Bust or Primer Pocket Swage.

Deluxe APP Kit 91898 **145.00**

INCLUDES PRESS, ROLLER HANDLE, PRIMING SYSTEM, APP DEPRIME KIT, UNIVERSAL CASE FEED MAGAZINE AND BOTTLE ADAPTER

Deluxe APP shown on optional Reloading Stand # 90688



OPTIONAL CASE COLLATOR

Fills all five tubes in just 10 seconds. Page 25, 26-27

92059 20.00



UNIVERSAL 5-TUBE CASE FEED MAGAZINE

92044 40.00

Automates case feeding process. Most handgun and short rifle, like the 223.



APP DEPRIME KIT

World's fastest, most convenient deprimer. Universal, no shell holder required.

91855 26.00



ROLLER HANDLE UPDATE KIT
91629 31.00

BREECH LOCK BULLET SIZING KITS



BREECH LOCK BULLET SIZING KIT

Uses inexpensive bullet sizer and punch, see page 38 for listing.

91532 20.00

FOR THE ULTIMATE IN CONVENIENCE, CONSIDER

INLINE BULLET SIZER MAGAZINE FILLER KIT

The kit includes a complete set of the bullet feed magazines and a special adapter.

When the magazine is full, simply transfer it to the LEE INLINE BULLET FEED DIE and never touch the bullet again!

ADD a magazine bullet feeder to your APP, three sizes cover .200 to .463 diameter bullets. See bottom pg 28 for listing.

INLINE BULLET SIZER MAGAZINE FILLER KIT

92019 (SEE PAGE 38)

APP press operation requires tube retainer and cap.

Tube retainer and cap
92022 10.00



X-PRESS SHELLHOLDER

The APP gets its speedy operation in part, by the use of a new shell holder. We call it the X-Press Shell Holder. It allows the case to pass through the shell holder after the operations are performed.

APP SHELL HOLDER	PRODUCT NO.	CARTRIDGES
#2	91535	45 ACP, 308 Win., 30-06
#4	91537	223 Rem, 5.56 NATO, 300 Blackout
#19	91552	40 S&W, 9mm Luger

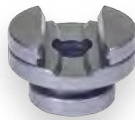

X-PRESS SHELL HOLDER
FOR APP PRESS
4.98 EACH



Scan QR code for complete listing
leeprecision.com/X-press-Shell-Holders-ID



X-PRESS SHELLHOLDER SET

CONTAINS
1 · 2 · 3 · 4 · 5
7 · 8 · 9 · 10 · 11 · 19

91622 45.00

BULGE BUSTER KIT FOR THE LEE APP



Lee APP Bulge Buster Kit

with appropriate Lee Factory Crimp Die restores free function of rimless cases that have low base bulges. Low base bulges usually occur from chambers that do not fully support the cartridge or cases resized in carbide dies from manufacturers other than Lee.

APP BULGE BUSTER KIT 91572 30.00



See page 9 for corresponding CARBIDE FACTORY CRIMP DIE

PRIMER POCKET SWAGE KIT

DESIGNED EXCLUSIVELY FOR THE LEE APP PRESS

Now you can swage primer pockets as fast as you can operate the press lever

The fastest, most convenient way to swage primer pockets. Will swage large and small primer pockets on any case up to 2 1/2 inches (30/06) long

No shellholders required!

Large and small swage punches included

Exclusive, case guided swage push die works without adjustment. Automatically aligns case mouth to receive the push rod and six guide fingers center the primer pocket to the swage punch. Nothing to adjust—simply install and begin swaging.

Swage adjustment is an finger adjustable knob; no tool required.

APP Prime Kit
90237 60.00



TWO GREAT WAYS TO TRIM CASES
QUICK TRIM OR CASE LENGTH GAUGE

FOR SAFETY SAKE TRIM YOUR CASES

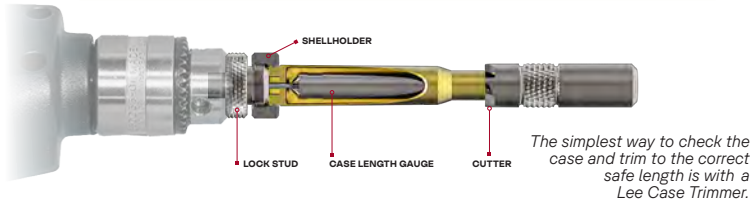

Lee Case Trimmer

After a case has been loaded a few times, it will stretch beyond maximum length and must be trimmed. There is no better system to check and trim cases than with the LEE CASE LENGTH GAUGE and CUTTER. You don't need an expensive caliper to set length and never waste even a single case setting up with the cut and try system common to all other brands. The piloted cutter assures the case mouths are absolutely square and true to the case neck. Best of all, the fixed length design assures it will never go out of adjustment.

The CUTTER and LOCK STUD works for all calibers. You will need only one. The CASE LENGTH GAUGE (PILOT) and SHELL HOLDER must be ordered as CASE LENGTH GAUGE and SHELL HOLDER for each caliber — see chart listing at right and opposite page. You can trim cases by hand, use an electric drill.



CUTTER AND LOCK STUD 90110 6.98
Fits cases up to .468" in diameter.

LARGE CUTTER & LOCK STUD 90401 9.98
Can be used on any case.



CUTTER ONLY WITH BALL GRIP 90275 9.98

THREADED LARGE CUTTER AND LOCK STUD 90468 9.98

Large cutter with 8-32 thread shank for use on popular powered case preparation centers.



CHAMFER TOOL Must be used after Case Trimming. Unique design cuts fast without chatter. One turn does the job. Chamfers and deburrs inside and outside of case necks. Can also be used to remove the crimp from primer pockets of military brass. Works better than tools costing several times as much.
90109 **3.98**



PRIMER POCKET CLEANER

Double ended design cleans both large and small primer pockets. Primers can be fully seated for better accuracy and safety. Costs so little and works so well, no reloader can afford to be without one.
90101 **2.98**



CASE CONDITIONING KIT

Includes cutter and lock stud, chamfer tool and primer pocket cleaner.
90950 **12.98**

DELUXE CASE CONDITIONING KIT

Includes everything in the case conditioning kit, plus the power grip shell holder.
92160 **17.98**



NEW

POWER GRIP SHELL HOLDER

Provides a comfortable grip for holding cases during case trimming and chamfering sessions. Install into all popular priming tools that accept Auto Prime shell holders. Rapidly trim brass to the appropriate length or chamfer the inside and outside of the case neck, quickly switch to the next piece of brass. Greatly improves the speed of switching between each piece of brass. No more loosening up the knurled shell holder between each piece of brass.
92149 **10.00**



* Ackley Improved Cases use standard parent cartridge Case Length Gauge

	QUICK TRIM DIE 16.00	Ltd. Prod. QUICK TRIM DIE 20.00	CASE LENGTH GAUGE 8.00	Ltd. Prod. CASE LENGTH GAUGE 13.00
17 Fireball		91347		
17 Hornet		90611		
17 Rem		90435		
204 Ruger	90439			
218 Bee		91350		90225
219 Zipper				91305
22 ARC		92190		
22 Creedmoor		92193		
22 Hornet	90354		90111	
*22/250	90284		90116	
220 Swift		91370	90118	
221 Fireball		91364	90112	
222 Rem Mag				91283
222 Remington	90340		90113	
*223 Remington	90179		90114	
223 WSSM		91358		90673
224 Valkyrie		90868	91339	
225 Winchester				91280
240 Weatherby Magnum				91281
243 Winchester	90320		90119	
243 WSSM		91341		90389
6MM GT		91979		
25 WSSM				90221
25-20 Winchester		91385		90121
25-35 Winchester				91306
25-06 Remington	90334		90124	
25-20 Winchester				90121
250 Savage (250/3000)		91374		90122
*257 Roberts		91357	90123	
257 Weatherby Magnum		91342	91298	
26 Nosler		90637		91307
260 Remington		90399	90993	
264 Winchester Magnum				91308
270 Weatherby Magnum				91279
270 Winchester	90229		90128	
277 Sig Fury		91991		
6.8 Western		91761		
270 Winchester Short Mag		90393	90117	
28 Nosler				91284
280 Rem ACK Improved		91375		91295
6.5 Weatherby RPM		91771		
284 Winchester		91362		90129
30-378 Weatherby Magnum				91309
30-40 Krag		91354	90137	
30/06 Springfield	90291		90140	
*30/30 Winchester	90249		90136	
300 AAC Blackout	90689		90443	
300 H&H			90407	
300 H&H or Ultra Magnum			90141	
300 HAM'R		91609		
300 RSAUM		91343		
300 Remington Ultra Magnum		91366		
300 Savage		91356	90138	
300 Weatherby Magnum		90408	90143	
300 Winchester Magnum	90441		90142	
300 Winchester Short Mag	90484		90034	
303 British	90325		90144	
303 Savage		91383		
308 Marlin		91352		
308 Norma Magnum				91289
308 Winchester	90231		90139	
32 Winchester Special				90491
32-40 Winchester		91376		91312
325 WSM		91344		90222
327 Federal Magnum				91303
338 Edge				91313
338 Federal				90218
338 Lapua			90462	
338 Remington Ultra Magnum				91314
338 Weatherby RPM		92037		
338 Winchester Magnum	90391		90149	
340 Weatherby Magnum				91223
348 Winchester		91360		91304
35 Remington		90403	90150	
35 Whelen		91355	90972	
350 Legend	91561		91567	

QUICK TRIM CASE TRIMMER

TRIM BRASS TO THE CORRECT LENGTH WHILE CHAMFERING THE CASE MOUTH



QUICK TRIM

The Deluxe Quick Trim Case Trimmer

quickly and precisely trims your brass to the correct length at the same time it chamfers the inside and outside of the case mouth. No calipers, measurement or adjustment required. Simply install the appropriate quick trim die in your press and start trimming. A click adjustable stop allows trim length adjustment in .001 of an inch increments. Allows the user to shorten case to a uniform shorter length than standard, reducing trimming frequency. Includes snap on chip catcher. Order appropriate Quick Trim die for each cartridge listed on chart on previous page and below.

90437 30.00

The ultimate in case trimming, speed and convenience



Deluxe Power Quick Trim

Trim and chamfer in a matter of seconds. Hex shank snaps in to cordless screwdriver or drill (sold separately). Includes power Quick-Trim adapter, chip catcher and deluxe cutter assembly. To complete your trimming setup, order cartridge specific Quick Trim die from chart from previous page and below.

90670 28.00

Cordless screwdriver pictured not included



* Ackley Improved Cases use standard parent cartridge Case Length Gauge



QUICK TRIM DIE	Ltd. Prod. QUICK TRIM DIE	CASE LENGTH GAUGE	Ltd. Prod. CASE LENGTH GAUGE
16.00	20.00	8.00	13.00

* Ackley Improved Cases use standard parent cartridge Case Length Gauge



QUICK TRIM DIE	Ltd. Prod. QUICK TRIM DIE	CASE LENGTH GAUGE	Ltd. Prod. CASE LENGTH GAUGE
16.00	20.00	8.00	13.00

350 Remington Magnum		91377		91315
358 Winchester				91318
375 H&H		90395		
375 H&H or Ultra Mag			90164	
375 Ruger		90613		91285
7mm PRC		92005		92031
375 Socom				91319
375 Super Magnum				91320
375 Winchester		91371		90165
40-65 Winchester		91384		91323
400 LEGEND	92081			
416 Rigby				91324
416 Ruger				91294
43 Spanish		91367		
444 Marlin		91372	90151	
45/70 Government	90458		90152	
45/70 LEVERevolution	92147			91287
450 Bushmaster			91325	
450 Marlin				90554
458 Lott				91326
458 Socom			91290	
458 Winchester Magnum		91345		90971
12.7x42mm fifty beowulf REQUIRES LARGE CUTTER			91292	
50 BMG REQUIRES LARGE CUTTER			90010	
6.5 Carcano		91353		90043
6.5 Creedmoor	90812		90814	
8.6 BLACKOUT		91978		92001
6.5 PRC	91348		91533	
6MM ARC	91665			92030
6.5 Grendel	90763			91278
6.5 x 284		91361		
6.5 x 284 / 6.5 Rem Mag			90223	
6.5 x 55 Swedish Mauser	90337		90126	
6.5-06				91108
6.5 X 47 Lapua		91381		91330
6.5 X 50 Japanese				91331
6.5 X 57 Mauser				91291
6.8 SPC		90397	90189	
6MM BR NOR/RE				91296
6mm Creedmoor		90658	91340	
6MM PPC		91349		91282
6mm Remington (244 Rem.)		90434	90120	
6MM TCU				91286
6MM XC				91328
6X45MM				91329
6X47 Lapua		91380		91302
7 x 57 Mauser	90489		90130	
7 x 64 Brenneke			90236	
7-30 Waters				91335
7.35 Carcano				91293
7.5 x 55 Swiss (Schmidt-Rubin)	90419		90132	
7.5 x 54 MAS		91359		90051
7.62 x 39 Russian	90345		90133	
7.62 x 54 Russian	90342		90147	
7.62 x 40 Wilson Tactical				91300

7.65 x 53 Mauser (Belgian-Arg)			91382	90134
7.7 x 58 Japanese Arisaka			91368	90115
*7mm Express/280 Rem.			90412	90166
7mm Remington Magnum	90297			90131
7MM RUM				91333
7MM STW				91332
7MM Weatherby Magnum				91334
7mm Winchester Short Mag			90314	
7mm/08	90343		90167	
7X64 Brenneke		91386		
8x56 Aust-Hung Mannlicher				90589
8x57 Mauser	90347		90148	
8MM Remington Magnum				91337
8X68MM S				91288
9.3x62 Mauser	90614		91299	
9.3x74 R				91301
22 TCM		91373		
5.7 x 28 FN			90219	
30 M1 Carbine	90365		90135	
9mm Makarov	90181			90684
9mm Luger	90032		90153	
357 SIG				91317
38 Super				90217
380 Auto	90025		90155	
30 Herrett				91297
7.62X25 Tokarev			91336	
32 ACP				91338
32 S&W				91311
32 Smith & Wesson Long				90169
32 H&R Magnum				91310
32-20 Winchester		91365	90146	
360 Buckhammer		92039		
38 S&W				90156
38 Special	90085		90157	
38-40 Winchester		91351		91322
38-55 Winchester		91379	90994	
357 Magnum	90088		90158	
357 MAX				91316
40 S&W	90033		90154	
10mm Auto	90193		90127	
38 Short Colt				91321
41 Magnum		90226	90159	
44-40 Winchester		91369	90168	
44 Special	90107		90160	
44 Magnum	90125		90161	
45 ACP	90073		90162	
45 Colt	90145		90163	
45 GAP				91473
454 Casull		90174	90992	
460 S&W				90220
480 Ruger REQUIRES LARGE CUTTER				90018
50 Action Express REQUIRES LARGE CUTTER				91327
500 S&W REQUIRES LARGE CUTTER				

UNLISTED RIFLE QUICK TRIM DIES can be custom made. leeprecision.com/custom-rifle-quick-trim-die-body

• \$26.00

UNLISTED CASE LENGTH GAUGES can be custom made. leeprecision.com/custom-case-length-gauge

CASE CONDITIONING TOOLS



DECAPPING UNIT

An absolute must for those who clean cases before reloading. No cleaning or lubing needed when using this die. Tough, almost unbreakable decapper easily removes crimped in primers. Fits cases up to .560" in diameter; up to 3.125" long.

DECAPPING UNIT 90292 15.98

UNDERSIZE FLASH HOLE

DECAPPING UNIT 91976 15.98

REPLACEMENT DECAPPER

UNGUIDED 90783 3.00
UNDERSIZE FLASH HOLE 91893 3.00

GUIDED 5.00

For smooth operation and less decapper bending or breaking, order caliber specific guided decapper.

91574 17 CAL-204 RUGER 91580 30 CAL
91576 22 CAL 91581 34-35 CAL
91577 6mm-25 CAL 91583 40 CAL
91578 27 CAL -7mm 91584 45 CAL

SECOND PIN FOR 1/3 MORE

DOUBLE END DECAPPING PINS

UNIVERSAL 91913 4.00
UNIVERSAL UNDERSIZE FLASH HOLE 91916 4.00

DECAPPER & BASE

Easily removes crimped in primers from military cases. Guaranteed unbreakable.

22 CALIBER 90103 30 CALIBER 90102 7.98



RAM SWAGE

Primer pocket swager works so fast that you'll want to swage all the range brass you pick-up. Works on all single stage presses with 7/8 -14 threads and accepts universal press shell holders. Features disc spring case extraction, and an all steel case guide, ensures cases will be positively centered on push rod. Shell holderless design, allows you to swage any small or large primer pocket, without swapping to a different size shell-holder.

91617 50.00

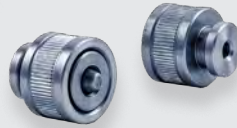

RAM SWAGE INSTALLED



UNSWAGED SWAGED



UNIVERSAL CASE EXPANDING DIE

Gently flares the case mouth to accept cast bullets without shaving. Works great to prevent damaging the moly and low friction coatings found on today's high performance jacketed bullets. Includes neck plugs for .22 cal through .45 cal. Works on everything from the 22 Hornet to the largest Ultra Mag. Costs so little and works so well you can't afford to be without one.

90798 18.00



LEE BULGE BUSTER KIT



Utilize all your brass by removing annoying bulge rings

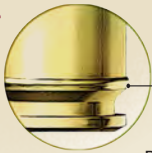

BULGE BUSTER KIT shown mounted to Breech Lock Reloader Press (90045). Sold separately, pg. 19

Assure your mixed brass is bulge free with the Bulge Buster Kit and appropriate Lee Carbide Factory Crimp Die. This push through die adapter will quickly remove the annoying bulge rings that shell holder constrained dies simply can't reach. The Bulge Buster Kit includes extension sleeve, push through punch, catch container and complete instructions. And it's fast — you can reprocess your cases as quickly as you can handle them.

CARBIDE FACTORY CRIMP DIES, SEE PAGE 9

BULGE BUSTER KIT 90487 19.98

90867	380 ACP
90862	10 mm
90862	40 S&W
90416	41 AE
90864	45 ACP
90864	45 GAP
90864	45 Win Mag

WITH THE LEE CARBIDE FACTORY CRIMP DIE, THE BULGE BUSTER WILL REPAIR ALL THESE RIMLESS CASES

Catch Container



Push through Punch

Extension Sleeve

THE EASIEST, MOST CONVENIENT BENCH MOUNTED PRIMING TOOL EVER

AUTO BENCH PRIME

Symmetrical design allows effortless right or left hand operation. Comfortable lever with just the right amount of mechanical advantage effortlessly seats even the most difficult primers with just finger pressure. Perfect mechanical advantage to feel the primer seating completely home into the primer pocket.

Auto Bench Prime
90700 **47.98**



INCLUDES PRIMING ASSEMBLIES FOR LARGE AND SMALL PRIMERS. CHANGE PRIMER SIZE OR SHELL HOLDER IN SECONDS.

Tray's built-in flipping surface quickly rights and orientates primers—go from box to priming in seconds. Patented elevator pin safely isolates a single primer for priming. Allows most primer brands and types to be safely tray fed. The convenient hinged cover allows you to individually feed primers if restricted by the primer manufacturer.

INCLUDES THE PATENTED REMOVEABLE FOLDING TRAY — GO FROM BOX TO PRIMING IN SECONDS. NO NEED FOR A HEAVY BENCH; FITS THE LEE BENCH PLATE OR MOUNT TO A BOARD FOR A PORTABLE SETUP.



Unfold tray and place on top of box of 100 primers.

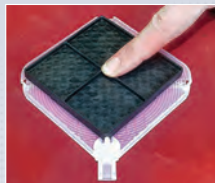

Flip tray over to deposit the primers.



Shake tray to upright all the primers. Fold and close cover.

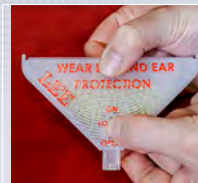

Slide the flow control to LOCK.

Folding Primer Tray
TWO PACK 90606 **9.00**



Auto-Prime

The original and world's most popular hand-held priming tool. Fast and economical hand held priming with unmatched feel and accuracy. Comes packed in a convenient storage box to keep your tool and shellholders together.

90230 32.98



See shellholder listing on leeprecision.com
leeprecision.com/priming-tool-shell-holders

Save even more! Purchase a kit!

Priming Tool Kit

Includes the Auto-Prime, and nice molded storage box. Holds everything, including a complete set of shell holders. Kit comes with 8 of the most popular priming tool shell holders; works with over 130 different cartridges—

| 1 | 2 | 3 | 4 | 5 | 11 | 12 | 19 |

Holds an additional 8 shell holders. Kit is a convenient way to keep tool and shell holders all in one spot.

90215 49.98



Set of Priming Tool Shellholders

Eleven of the most popular sizes fit over .115 different cartridges. Additional cartridge listings on leeprecision.com



1 · 2 · 3 · 4 · 5 · 7 · 8 · 9 · 10 · 11 · 19
PRIMING TOOL SHELLHOLDER SET 90198 **28.98**
with 11 Shellholders for LEE PRIMING TOOLS AND THESE OTHER FINE TOOLS—K&M, SINCLAIR, F A PLATINUM, CPS, 21ST CENTURY
RED STORAGE BOX ONLY 90196 **4.98**

SHELL HOLDER	FOR PRIMING TOOL SHELL HOLDERS
	4.98
#1	90201
#2	90202
#3	90203
#4	90204
#5	90205
#6	90206
#7	90207
#8	90208
#9	90209
#10	90210
#11	90211
#12	90212
#13	90213
#14	90272
#15	90017
#16	90200
#17	N/A
#18	N/A
#19	90023
#20	90020
#21	90031
#24	91495
#25	91496

DELUXE PERFECT POWDER MEASURE

QUALITY CONSTRUCTION

This powder measure features a high pressure die cast, diamond-machined body. The precision-machined rotor drum is cast from brass, which is naturally anti-static and spark proof.

ELIMINATES CUT POWDER AND JERKY ACTION

A soft elastomer wiper strikes off the metering chamber rather than cut the powder. You'll be surprised at how smoothly the rotor operates. More importantly, you will enjoy the most uniform of charges.

EASY TO SET MICROMETER METERING CHAMBER

Powder charge adjustment is accomplished with a true micrometer adjustable metering chamber. The metering chamber is aluminum with a black anodized finish. Features a crisp, laser engraved scale. The brass micrometer thimble is engraved with .01cc graduations and has a releasable detent lock. With most rifle powders each click is about a 1/10 of a grain, perfect for working up a load.

CHANGING POWDER IS FAST AND EASY

Features removable hopper with an on/off valve so you can quickly return unused powder to its original container or switch to another type. The hopper feeds to a pre-measuring chamber allowing precise charges regardless of the powder level in the hopper, eliminates the need for an extra powder baffle.

QUICK CHANGE DRUMS

One of the nicest features is the ability to use the new Lee standard quick-change drums. These low cost drums can be preset to your favorite charge and swapped out in seconds.

DELUXE PERFECT POWDER MEASURE 90699 92.00



PICTURED ON OPTIONAL STAND # 90587, SOLD SEPARATELY



Lee Safety Scale

Safety and accuracy are the most important features

This is the only scale that can never get out of adjustment. The beam is made from a very tough phenolic, the same type material used on table and counter tops. Phenolic is tough but, like glass, it can't be bent. Even if dropped you can feel confident that if it did not break it is still accurate. Sensitive and readable to 1/20 grain.

90681 48.98

READ THIS IF YOU ALREADY HAVE A COMBINATION BULLET AND POWDER SCALE

Try this simple test to see how sensitive your scale really is. Cut a piece of regular writing paper or this catalog 5/16 inch square. With scale set on zero — drop the paper on the pan to see if it moves. It should read about .1 grain. Keep adding paper squares until it does move. The total number of squares needed to move your scale is your scale's sensitivity. We have seen digital powder scales that are only sensitive to 1/2 grain (FIVE paper squares!) A Lee Safety Scale will move with the first paper.

NO POWDER MEASURE REGARDLESS OF PRICE, HAS ALL THE FEATURES OF THE LEE DELUXE POWDER MEASURE

POWDER MEASURE STAND

Heavy, powder coated steel construction

7/8" mounting hole for all popular measures

Includes 3 no slip feet

Rock solid mount improves measure consistency

Space saving freestanding design is portable and convenient.

Works with other brands of powder measures

POWDER MEASURE STAND 90587 50.00



QUICK CHANGE DRUM SET

Features four precision molded nylon drums. Two small capacity for cases as small as the 25 ACP, adjustable to 223 size rifle cases. Large capacity drums adjustable from 223 case to large belted magnums. The large drums include an insert to allow reduced capacity charging like the small drum. All drums are infinitely adjustable within range. No tools required for adjustment. Adjustment key is marked with .01cc graduations, allowing easy 1/10-grain powder adjustments.

QUICK CHANGE DRUM SET 90453 20.00



POWDER MEASURE BOTTLE ADAPTER

POWDER MEASURE BOTTLE ADAPTER FITS ALL LEE POWDER MEASURES



Dispense powder directly from the shipping container of most popular powder manufactures. Includes crystal clear bottle that holds over a half a pound of ball powder. Works on all of these containers and many more. (53mm or 43mm thread) Dispensing powder directly from the bottle assures positive identification of the powder type.



Adapter is manufactured from Polypropylene — resistant to attack from all types of powder. Turn off the powder flow and store your powder in its original container with no fear of misidentifying or damage to your hopper from chemical attack. Viewing window allows monitoring powder level in use without removing bottle.

BOTTLE ADAPTER 91586 8.00

Lee Powder Measure Kit

Fifteen uniformly graduated and proportioned powder dippers. Slide card shows the grains of powder each measure will dispense of every type of powder. Powder measures are inherently safe as they cannot get out of adjustment. That's why powder dippers continue to be the first choice of reloaders who load in small quantities.

90100 15.98

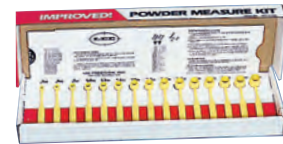

Powder Funnel

A large, unbreakable funnel that fits all cases from .22 to .45 caliber. Hole in flange permits mounting to the Lee Turret Press, shelf or bench.



90190 4.98

INCLUDES THE NEW POWDER MEASURE BOTTLE ADAPTER

The Original Perfect Powder Measure

Almost as good as a scale!

Solves problems common to ordinary drum type measures. Gives you the confidence that your charges will be the most uniform possible.

Lee Perfect Powder Measure

Includes many of the features of the Deluxe Perfect Powder Measure, but the body is molded from an engineering grade polymer. Rotating micrometer adjustable metering chamber and elastomer wiper to prevent powder cutting. Works better than other powder measures priced four times as much.

90058 30.98



FREE STURDY STEEL MOUNTING BRACKET INCLUDED WITH EACH MEASURE

CHARGE CASES

WHILE EXPANDING THE CASE MOUTH

“MODERN RELOADING” AND ALL POPULAR LEE DIE SETS INCLUDE LOAD DATA

Lee Pro Auto-Disk Powder Measure

Commercial reloaders or competitive shooters first choice! Elastomer wiper and polytetrafluoroethylene (PTFE) non-stick metal casting make this the smoothest operating measure. Large hopper with integral shut-off valve makes changing powder or disks super convenient. Brass thumbnuts attach the hopper to the body so you can change disks with no tools. Rubber wiper and seal prevents powder shearing and makes it more leak-resistant with fine-grain powders. Increased safety with positive pull-back lever.

The measure is attached to the die with a swivel adapter, allowing easy positioning and quick removal when changing cartridges.

Included positive pull back lever reduces the chance of double charge when progressive reloading.

LEE PRO AUTO-DISK POWDER MEASURE
INCLUDES ALL FOUR DISKS

90429 60.00

PRO AUTO-DISK POWDER MEASURE	
CARTRIDGE RANGE	9 MM TO 45 COLT
USE	IDEAL FOR HANDGUN
SIMPLE SET UP	NOTHING TO ADJUST, NOTHING TO GET OUT OF ADJUSTMENT USE LEE PUBLISHED LOAD DATA
CONSISTENCY	EXTREMELY CONSISTENT INCREMENTAL CHARGES
WIPER TO PREVENT POWDER SHEARING	YES
SWIVEL ADAPTER FOR FAST, EASY TRANSFER	YES
ON/OFF VALVE	YES

The Pro Auto-Disk comes with a complete set of four disks. Each disk has six cavities, so you get 24 cavities in all. The chart included on the rear of the instruction sheet lists the capacity of each cavity with every type of powder.

If you reduce your charge 10% you can safely use this data without weighing your charge. Fixed cavities are the safest way to meter powder because they can't be misadjusted or get out of adjustment.

PRO AUTO-DISK ACCESSORIES



ADJUSTABLE CHARGE BAR

Infinitely adjustable between .28 and 1.6 cc. Lifetime nylon with solid brass, zero backlash micrometer. Easy to set.

ADJUSTABLE CHARGE BAR
90792 9.98

DOUBLE DISK KIT (NOT PICTURED)

This kit raises the hopper so you can stack two disks. Not only doubles the capacity of the disks but makes very fine adjustments possible. Most powders can be adjusted up or down .1 grain with different combinations of disks. Complete listing of combinations, 4 extra disks, screws and risers included.

LEE DOUBLE DISK KIT
90195 14.98

LEE RIFLE CHARGING ADAPTER KIT

Short and Long Charging Adapters are included. These work the same as the pistol powder through expanding dies, except they do not expand the case mouth. Rifle case expansion is done in the sizing die. Can be used on 22 caliber, and up to the largest belted magnums.

CHARGING ADAPTER KIT
90995 29.00

SHORT CHARGING ADAPTER
22 HORNET TO 223 REM
90668 16.98

LONG CHARGING ADAPTER
223 REM TO 300 WIN MAG
90194 16.98

AUTO DRUM

Automatic case actuated drum powder measure. Accurately and automatically dispense powder in your favorite cartridge. Two infinitely adjustable drums included. Quick Change drums accurately and reliably drop charges from 1 to 80 grains of powder.

- ▶ Case actuated; never spill a charge.
- ▶ Exclusive elastomer wiper prevents powder shearing, works great with difficult metering extruded powders.
- ▶ Machined body with labyrinth groove mates to precision molded nylon drums providing leak free fit with the finest powders.
- ▶ Drum is actuated by a sector and pinion gear train.
- ▶ Quick-change hopper has on/off valve Sleek modern design, all gears springs and levers inside die cast housing.
- ▶ Same swivel adapter as our famous Pro Auto-Disk powder measure. Makes moving measure fast and convenient.

HANDGUN AND RIFLE DRUMS INCLUDED

DELUXE AUTO-DRUM POWDER MEASURE
92003 65.00

AUTO-DRUM POWDER MEASURE	
CARTRIDGE RANGE	25 AUTO TO 300 WIN MAG
USE	IDEAL FOR BOTH HANDGUN AND RIFLE
ADJUSTABILITY	INFINITELY ADJUSTABLE WITH INCLUDED SMALL AND LARGE QUICK CHANGE DRUMS
CONSISTENCY	EXTREMELY CONSISTENT .01 CC INCREMENTAL CHARGE ADJUSTMENT
WIPER TO PREVENT POWDER SHEARING	YES
SWIVEL ADAPTER FOR FAST, EASY TRANSFER	YES
ON/OFF VALVE	YES

AUTO-DRUM POWDER MEASURE
90811 55.00

POWDER MEASURE RISER Installs between the Lee Powder through Expanding Die or Rifle Charging Die and Powder Measure. Allows convenient use of other brands of dies that have extended adjusting screws and provides clearance for the Lee Safety Prime.

POWDER MEASURE RISER
90041 9.98

DELUXE AUTO-DRUM UPDATE KIT
92084 25.00

NOTE Pro Auto-Disk and Auto-Drum Powder Measures must be used with the powder through expanding die supplied with all Lee pistol dies, or Lee Rifle Charging Dies (see left). These dies may be purchased individually.

Only Lee Dies permit charging the case while expanding the case mouth.

POWDER THROUGH EXPANDING DIE



LEE
MAKES
BULLET
CASTING
EASIER



Lee Pro 4-20

Large diameter high capacity pot, holds approximately 20 pounds of lead. Nearly 4 inches of clearance under the spout accepts all brands of bullet molds and most sinker molds. It also includes an adjustable mold guide to quickly and accurately position any mold for pouring.

This second generation design incorporates the famous Lee patented high-efficiency design and dependable remote sensing thermostat, in a dust tight housing. Long life 700-watt tubular heating element assures quick melting and rapid recovery. Micro adjustable, flow control valve adjusts instantly with a twist of the screwdriver. Front mounted low maintenance replaceable valve spout allows instant reseating with a turn of a screwdriver.

LEE PRO 4-20	90947	110 VOLT	132.00
EXPORT MODEL	90948	220 VOLT	137.00

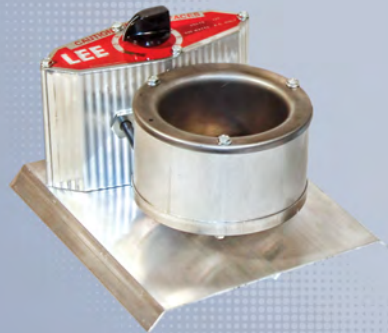

Lee Precision Melter

High speed melter with an infinite heat control for the budget caster. Easily handles 4-cavity molds. Takes less than 15 minutes to melt 4 pounds of metal. Same infinite heat control as used on the Production Pot. 500 watts AC only. Guaranteed 2 years.

PRECISION MELTER, 110V	90021	71.00
EXPORT MODEL, 220V	90024	79.00

UNIQUE
INFINITE
HEAT CONTROL

A highly reliable control, mounted away from the high heat of the pot. Eliminates failures usually associated with thermostatically controlled units. Thermal feed back to the infinite control permits heater to put out full power until metal has melted.



Magnum Melter

Large 4-inch diameter pot allows easy access for the ladle caster. Same high efficiency design that has made Lee pots the most popular. Melt time is less than 20 minutes with just 700 watts. 20-lb. capacity for the longest casting session.

MAGNUM MELTER	110 VOLT	90949	103.00
----------------------	-----------------	--------------	---------------



Lee Production Pot IV

Large, deep pot holds approximately 10 pounds of lead. Melt time is less than 20 minutes. Pour spout up front where it belongs so you can see what you're doing. Infinite heat control. Uses only 500 watts of power during heat-up and a lot less to maintain temperature. Large, stable base for safety. 4" of clearance under the spout is high enough to accept all brands of bullet molds and most sinker molds.

PRODUCTION POT IV	110 VOLT 90009	115.98
--------------------------	-----------------------	---------------

EXPORT MODEL	220 VOLT 90008	120.98
---------------------	-----------------------	---------------



Ready To Cast Kit

The Ready to Cast kit has everything you need to start casting, plus your choice of a free double cavity bullet mold or ingot mold!

Kit includes the 110 Volt Production Pot IV (North American customer's only), Lead Ladle, Mold Mallet and redemption post card to select FREE mold.

110 VOLT 92201	136.00
-----------------------	---------------



LEE MOLD MALLET

Features ash hardwood construction. Cut the sprue and release the bullets with one handy tool. Ergonomic design makes it convenient and comfortable to use with long casting sessions. Mallet is 10 inches long.

90084	10.00
--------------	--------------



LEE INGOT MOLD

Use to cast 1/2 and one pound ingots. Perfect for remelting and alloying. Wood handles stay cool. Aluminum mold is lightweight and rustproof.

90029	27.98
--------------	--------------

LEE LEAD LADLE

A convenient size ladle for bullet casting. Works equally well for right and left handers. Handy for skimming and stirring metal.

90026	9.98
--------------	-------------



WARNING Melting lead and casting lead objects will expose you and others in the area to lead, which is known to the State of California to cause reproductive harm and cancer. For more information, www.P65Warnings.ca.gov. See instructions on reducing exposure supplied with product.

B R E E C H L O C K S I Z I N G

Bullet Sizer and Punch 12.00

Compact bullet sizer made from high carbon steel. The bore is specially tapered to reduce sizing effort. Most important, taper gently and precisely reduces bullet to the correct diameter. It never damages your powder or liquid coating by shaving. The punch snaps into any reloading press shell holder slot. The steel punch pushes on the base of the bullet so there is no possibility of nose distortion. Plus, the nose first sizing allows gas checks to be seated and crimped in one operation.

BE SURE TO ORDER THE BREECH LOCK KIT TO SUIT YOUR NEEDS

DIA.		DIA.		DIA.	
.224	91505	.356	91518	.451	91526
.225	91506	.357	91519	.452	91527
.266	91775	.358	91520	.454	91528
.308	91511	.401	91521	.457	91529
.309	91512	.410	91522	.458	91591
.311	91513	.427	91523	.459	91616
.312	91623	.429	91524	.460	91592
.314	91514	.430	91525	.501	91530
.323	91515	.450	91671	.510	91531



Over 150+ sizes available on our website. Other sizes can be made on a custom basis. Scan QR code for details.

Breech Lock Bullet Sizer Kit

Works in any Breech Lock Press
Uses inexpensive bullet sizer and punch.

Great for the casual reloader

INCLUDES BOTTLE that holds 100 bullets. Adapter also fits most powder containers for larger capacity.



Breech Lock Bullet Sizing Kit
91532 20.00

RELOADER PRESS shown with Breech Lock Bullet Sizer installed
PRESS NOT INCLUDED



Inline Bullet Sizer Magazine Filler Kit

Kit contains everything you need to use the Bullet sizer and punch with the Lee Inline Bullet Feed magazine. Now you can size bullets and simultaneously fill the Lee Gatling style magazine feeder. The system works so well—once bullet is sized you will never touch it again. Simply transfer filled magazine to press and start loading. Includes small, medium & large magazines with matching drop tubes and supports, Breech Lock bullet sizer and special adapter. Works with .220 to .463 diameter bullets. Order bullet sizers and punches at left. Use QR code to see expanded list of sizes.

Inline Bullet Sizer Magazine Filler Kit
92019 65.00

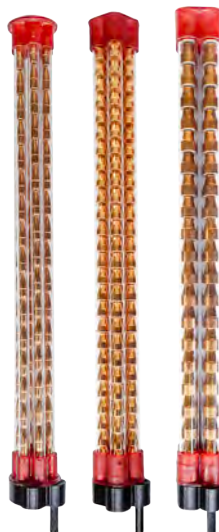

RELOADER PRESS shown with Inline Bullet Sizer Magazine Filler Kit
PRESS NOT INCLUDED



DIA.		DIA.		DIA.	
.224	90049	.329	90934	.451	90061
.225	90036	.339	90576	.452	90055
.243	90083	.356	90046	.454	90056
.266	92067	.357	90047	.457	90057
.278	90261	.358	90048	.458	91682
.284	90170	.376	91856	.459	91672
.285	90171	.401	90060	.460	91829
.308	90037	.409	91728	.501	90191
.309	90038	.410	90052	.510	90188
.311	90039	.427	90053		
.314	90044	.429	90054		
.323	90686	.430	90062		



Classic Bullet Sizing Kit

The kit that made nose first bullet sizing affordable for over a generation. Standard 7/8-14 threads fit most reloading presses. Bullets are pushed through nose first so no special nose punches are required. The included punch snaps into any standard press ram. Gas checks are automatically seated and crimped in place. Sized bullets captured in the provided special container. COMPLETE FOR ONE SIZE 25.98

NOTE ALL BULLETS MUST BE LUBRICATED OR POWDER COATED FOR SIZING. ORDER LEE LIQUID ALOX BELOW

Other sizes can be made on a custom basis. Scan QR code for details.

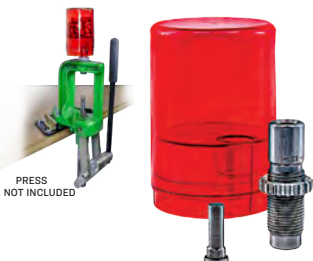

L U B R I C A T I N G B U L L E T S



Lee Liquid Alox

Lee Liquid Alox gives better accuracy because it eliminates leading. The lube coats the entire bullet like a thin jacket and dries to a soft, varnish-like finish that really clings. The dried coating does not degrade gunpowder. Easy to apply; eliminates the need for sizing of most cast bullets. While it works well with all cast or swaged bullets better than any other lube, it works most economically with micro band bullets, which are designed for tumble lubing.

4 OZ. DISPENSER BOTTLE 90177 9.98

Enough for thousands of bullets

Try this

with your bullet lubricant



The bullet melts while the Lee Liquid Alox clings tenaciously to the bullet

Traditional bullet lubricating methods of placing lube only in the grooves are inferior to the modern method of coating the entire bullet with Lee Liquid Alox. This places the lube where needed, on the surfaces that rub against the bore.



Gently shake bullets in an orbital motion to coat the bullets. If they do not coat completely, add a little more lube.



Spread bullets onto waxed paper and let dry overnight.

Universal Case Expanding Die

Gently flares the case mouth to accept cast bullets without shaving. Works great to prevent damaging the moly and low friction coatings found on today's high performance jacketed bullets. Includes neck plugs for .22 cal through .45 cal. Works on everything from the 22 Hornet to the largest Ultra Mag. Costs so little and works so well you can't afford to be without one.

90798 18.00



Hardness Testing Kit

Featured product in CHAPTER 10 "MODERN RELOADING." No more wasted components shooting too soft or too hard lead. Cast and load with confidence knowing your alloy is up to the job. Quickly and precisely check hardness of your lead alloy. Exclusive conversion chart tells the maximum operating pressure of any lead alloy.

90924 110.00 INCLUDES

CALIBRATED HARDENED STEEL BALL INDENTER V" BLOCK CRADLE SNAPS INTO STANDARD PRESS RAM 20 POWER 4 LENS OPTICAL MEASURING MICROSCOPE





MOLD NUMBER CODE



LEE BULLET MOLDS
DOUBLE CAVITY MOLDS
Handles, sprue plate included.
44.98

HOLLOW BASE MOLDS
Available in single cavity only. Self centering automatic core pins for the fastest possible molding. Handles and sprue plate included.
55.98

SIX CAVITY COMMERCIAL QUALITY MOLDS
Made for heavy duty volume production. Handles extra.
65.00

MOLD HANDLES
Precision steel mold handles fit not only Lee Six Cavity molds and 18 Cavity Buckshot molds, and most other brands of one and two cavity molds.
90005 **28.98**



MOLD HANDLES & STORAGE BOX
92158 **33.98**

RIFLE & PISTOL BULLET MOLDS

RIFLE BULLET MOLDS

	22 CAL	6.5mm	270	7mm	30 CALIBER RIFLE		
BALLISTIC COEFFICIENT	.155	.333	.310	.305	.154	.163	.224
MOLD	C225-55-RF	C266-140-RF	C277-135-RF	C285-130-R	C309-113-F	C309-120-R	C309-150-F
DOUBLE	90451	92032	90454	90360	90362	90364	90366
6 CAVITY	90459						
LUBE & SIZE	90036		90261	90171	90038	90038	90038
BL BULLET SIZER	91506	91635	91508	91510	91512	91512	91512

RIFLE BULLET MOLDS

	30 CALIBER RIFLE					BEST SUBSONIC REQUIRES FAST TWIST RIFLING		7.62 X 39	303 BRIT	8 mm	8 x 56	338 CAL
BALLISTIC COEFFICIENT	.252	.268	.317	.352	.688	.268	.276	.247	.216	.361	.250	
MOLD	C309-160-R	C309-170-F	C309-180-R	C309-200-R	TL309-230-5R	C312-155-2R	CTL312-160-2R	C312-185-1R	C324-175-1R	C330-205-1R	C338-220-1R	
DOUBLE	90367	90368	90369	90370	90307	90385	90361	90371	90274	90775	90372	
6 CAVITY						90741	90579					
LUBE & SIZE	90038	90038	90038	90038	90038	90039	90039	90039	90686	custom	90576	
BL BULLET SIZER	91512	91512	91512	91512	91512	91513	91513	91513	91515	91632	91517	

RIFLE BULLET MOLDS

	35 REM	375 Win 38/55	41 Swiss	45 - 70 CALIBER RIFLE							50 - 70 CAL	
BALLISTIC COEFFICIENT	.186	.250	.228	.211	.225	.250	.250	.278	.443	.220	.283	
MOLD	C358-200-RF	379-250-RF	418-320-RF	457-340-F	457-405-F	459-405-HB	457-450-F	C457-500-F	459-500-3R	515-450-F	515-500-F	
DOUBLE	90449	90324	92204	90373	90374		90375	90376	90577	90255	90266	
6 CAVITY	90016											
HOLLOW						90268						
LUBE & SIZE	90048	custom	custom	90057	90057	91672	90057	90057	91672	custom	custom	
BL BULLET SIZER	91520	90324	custom	91529	91529	91616	91529	91529	91616	91590	91590	

LEE BULLET MOLDS | PISTOL



TRADITIONAL GROOVE

This type of lubrication groove is designed for old style hard lubricants. Also works well with Lee Liquid Alox.



MICRO BAND GROOVE FOR LIQUID ALOX #90177

The reduced friction of the micro bands allow a higher velocity with the same pressure as conventional lube grooves.

MICRO BANDS USUALLY REQUIRE NO SIZING

The bullet shank has many shallow grooves for maximum liquid lubricant retention. A great way to make bullets in quantity with minimum time, effort and equipment. More accurate than ordinary cast bullets. The reduced friction of the micro bands gives you more velocity with less pressure.

PISTOL BULLET MOLDS

	32/20	32 S&W LONG	32 COLT NP	38 SPECIAL • 38 S & W • 38 COLT NEW POLICE • 357 MAG						
BALLISTIC COEFFICIENT	.125	.174	.100	.106	.116	.142	.072	.072	.131	.117
MOLD	311-93-1R	311-100-2R	TL314-90-SWC	358-105-SWC	358-125-RF	358-140-SWC	TL358-148-WC	358-148-WC	358-150-1R	TL358-158-SWC
DOUBLE	90300	90301	90311	90316	90574	90318	90279	90312	90328	90321
6 CAVITY	90308			90315	90306	90317	90294	90380	90326	90295
LUBE & SIZE	90039	90039	90044	90048	90048	90048	90048	90048	90048	90048
BL BULLET SIZER	91513	91513	91514	91520	91520	91520	91520	91520	91520	91520

PISTOL BULLET MOLDS

	38 SPL • 38 S&W • 38 COLT NP • 357 MAG			9mm LUGER • 38 SUPER AUTO • 380 AUTO						
BALLISTIC COEFFICIENT	.117	.207	.160	.107	.105	.123	.164	.127	.166	.195
MOLD	C358-158-SWC	TL358-158-2R	358-158-RF	TL356-95-RF	356-102-1R	356-120-TC	TL356-148-WC	TL356-124-TC	356-125-2R	356-147-TC
DOUBLE	90322	90388	90303	90601	90305	90239	90464	90238	90309	92043
6 CAVITY	90327	90319	90692	90672	92194	90387	90465	90402	90457	92045
LUBE & SIZE	90048	90048	90048	90046	90046	90046	90046	90046	90046	90046
BL BULLET SIZER	91520	91520	91520	91518	91518	91518	91518	91518	91518	91518

PISTOL BULLET MOLDS

	9 MM MAKAROV	40 S & W • 10 MM AUTO			41 MAGNUM	
BALLISTIC COEFFICIENT	.093	.117	.141	.141	.110	.119
MOLD	365-95-1R	401-145-SWC	TL401-175-WC	401-175-TC	410-195-SWC	TL410-210-SWC
DOUBLE	90466	90470	90431	90256	90330	90335
6 CAVITY			90433	90690		
LUBE & SIZE	custom	90060	90060	90060	90052	90052
BL BULLET SIZER	91743	91521	91521	91521	91522	91522

Custom Molds We can produce custom bullet molds within certain limits. The prices are the same as our standard molds, but there is a tooling and set-up charge. If interested in this service, please access design assistance sheet on www.leeprecision.com. This outlines the basic limitations of our manufacturing process.



<https://leeprecision.com/files/instruct/MoldDesignAssistance.pdf>

WARNING Melting lead and casting lead objects will expose you and others in the area to lead, which is known to the State of California to cause reproductive harm and cancer. For more information, www.P65Warnings.ca.gov. See instructions on reducing exposure supplied with product.



LEE BULLET MOLDS

DOUBLE CAVITY MOLDS
Handles and sprue plate included.
44.98

SIX CAVITY COMMERCIAL QUALITY MOLDS
These are made for heavy duty volume production. The mold blocks have steel bushing and alignment pins for lasting precision. Price includes a cam operated sprue plate to eliminate the pounding common to ordinary molds. The sprue plate is hard anodized and held down with wave washers at each end. No finer mold can be purchased at any price. Handles extra.
65.00

MOLD HANDLES
Precision steel mold handles fit not only the Lee Six Cavity molds and 18 Cavity Buckshot molds, and most other brands of one and two cavity molds. Priced low enough so you can have a set for every pair of blocks.
90005 **28.98**

MOLD HANDLES & STORAGE BOX
92158 **33.98**



LEE MOLDS FEATURE Trochoidal Venting



Unique venting on the mold face and sprue plate mating surface allows consistent and effortless fill out.



LEE MOLD BLOCKS MADE FROM ALUMINUM BECAUSE OF THE EXCEPTIONAL MOLDING QUALITIES

CNC-MACHINED MOLD CAVITIES FOR UNMATCHED ROUNDNESS AND SIZE CONTROL

MOST BULLETS FROM LEE MOLDS CAN BE USED AS CAST WITHOUT SIZING

PISTOL BULLET MOLDS										
	44 SPECIAL • 44 MAGNUM • 44/40						45 ACP • 45 AUTO RIM • 45 COLT			
BALLISTIC COEFFICIENT	.111	.124	.124	.196	.169	.218	.090	.127	.140	.127
MOLD	429-214-SWC	C429-240-SWC	429-200-RF	429-240-2R	TL430-240-SWC	C430-310-RF	452-160-RF	452-200-SWC	452-200-RF	TL452-200-SWC
DOUBLE	90336	90338	90285	90341	90299	90858	90570	90348	90234	90463
6 CAVITY		90483	90428	90339	90357	90227		90310	90697	90379
LUBE & SIZE	90054	90054	90054	90054	90062	90062	90055	90055	90055	90055
BL BULLET SIZER	91524	91524	91524	91524	91525	91525	91527	91527	91527	91527

PISTOL BULLET MOLDS										
	45 ACP • 45 AUTO RIM • 45 COLT						45 COLT 454 CASULL	475 LINEBAUGH	50 BEOWULF 500 S&W	500 S&W
BALLISTIC COEFFICIENT	.145	.189	.146	.146	.136	.210	.233	.271	.199	.296
MOLD	452-228-1R	TL452-230-2R	TL452-230-TC	452-230-TC	452-252-SWC	452-255-RF	452-300-RF	476-400-RF	C501-350-RF	C501-440-RF
DOUBLE	90351	90346	90287	90290	90356	90358	90359	90241	92166	90991
6 CAVITY	90352	90350	90286	90289		90349	90228			
LUBE & SIZE	90055	90055	90055	90055	90055	90055	90055	custom	90191	90191
BL BULLET SIZER	91527	91527	91527	91527	91527	91527	91527	91657	91530	91530

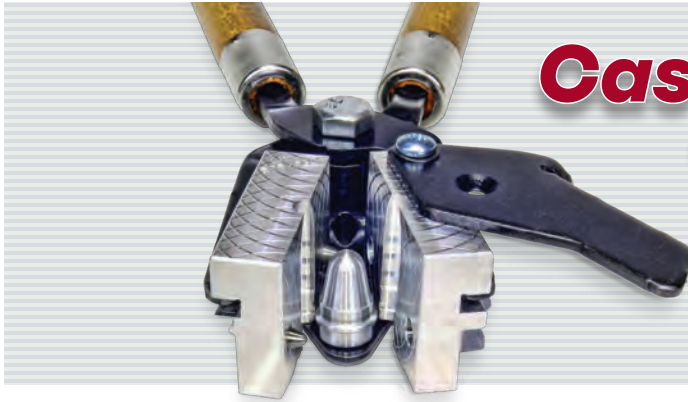

Cast Minie Bullets as fast as Round Balls

Minie Bullet Mold

AUTOMATIC CORE PIN MOLD. Open mold upside down to empty. Close it and you're ready to cast the next. The core pin automatically centers in the mold. Easily cast 200 per hour. A quality mold built to last as long as your rifle.

COMPLETE W/ HANDLES AND AUTOMATIC CORE PIN 55.98



Round Ball Molds

Have tangential cut off which eliminates the objectional nib at the sprue.

DOUBLE CAVITY WITH HANDLES 45.98
6-CAVITY WITHOUT HANDLES 65.00

SIZE	DOUBLE	SIZE	DOUBLE	SIZE	DOUBLE
.311	90406	.440	90436	.535	90456
.319	90410	.445	90438	.562	90460
.350	90415	.451	90440	.575	90461
.360	90418	.454	90442	.600	90975
.375	90420	.457	90444	SIZE	SINGLE
.380	90423	.490	90448	.690	90978*
.390	90424	.495	90450	<small>*DUE TO THE DIAMETER, MOLD SHIPS AS A SINGLE CAVITY.</small>	
.395	90425	.500	90452	SIZE	6 CAVITY
.433	90432	.530	90283	.490	91711▲

▲ Handles #90005 28.98

Handles with storage box #92158 33.98

Improved Minie, Traditional Design



45 Cal.	.450-294M	90467
45 Cal. oversize	.454-298M	90469
50 Cal.	.500-360M	90472
54 Cal.	.533-410M	90473
54 Cal. oversize	.540-415M	90474
58 cal.	.575-472M	90476
58 cal. oversize	.578-478M	90478

Improved design is easier to cast and load. Usually more accurate; a wider variety of sizes.



Modern Minie, Target Design

50 Cal.	.500-354M	90471
---------	-----------	-------

The most accurate of all Minies. Makes nice, clean holes in the target. The first choice for highest scores.



Original Style Minie Bullet

58 Caliber	575-500M	90481
------------	----------	-------

An extremely popular, traditional size Minie bullet. Available in 58 caliber only. Certainly a must for authentic muzzle loading shooting.

RIFLING · ENGRAVED · AT · LOADING



A BULLET FOR MUZZLELOADERS

A solid bullet that loads easily even after many firings because of its unique cleaning action. Will not tumble. A perfect hunting bullet with heavy loads. Easy to cast. Shoots accurately even in greatly oversize barrels.

DOUBLE CAVITY WITH HANDLES 44.98

	GRAINS	DOUBLE
45 Cal.	200	90390
45 Cal.	250	90392
50 Cal.	250	90394
50 Cal.	320	90396
54 Cal.	300	90398
54 Cal.	380	90400
58 Cal.	440	90404



Combo Molds

45 CAL 200RB WITH HANDLES 90405 44.98

Double cavity mold casts one 45 Cal. 200 R-E-A-L bullet and one .440 diameter Round Ball.

50 CAL 320RB WITH HANDLES 90488 44.98

Double cavity mold casts one 50 Cal. 320 R-E-A-L bullet and one .490 diameter Round Ball.

RIFLING-ENGRAVED-AT-LOADING

The driving bands are large enough to adequately engage the rifling when pushed into the muzzle, and thin enough to easily engrave. They're strong enough to withstand maximum charges without stripping or gas cutting.

UNIQUE CLEANING ACTION

You can shoot all day without cleaning your rifle between shots! When inserted into the muzzle, tiny scraping edges are swagged forward on each driving band. These perfect fitting scrapers remove the fouling from the previous shot.

EASIER, FASTER TO LOAD

It's easy to load straight and true, easier and faster than a round ball

with patch. Easily stabilized with very light charges, the R-E-A-L bullet also retains accuracy with maximum loads. Each band is generously tapered to the rear with an angle close to that of a lathe center, so as to center the bullet against the rifle bands. When pushed in, the bullet automatically centers in the bore.

MORE ACCURATE

The bevel base of the R-E-A-L bullet contributes to greater accuracy. When the bullet exits the bore, the gas escapes equally around the perimeter of the base. The uniform bevel is resistant to nicks that would permit gas to escape prematurely and cause a jet effect on one side of the bullet.



Conical Bullet Mold FOR BLACK POWDER REVOLVERS

A super accurate bullet that is easy to load straight and true. Two lube grooves prevent flash ignition and lead fouling. More energy and far greater accuracy than round balls.

36 Cal. 375-130-1R	90378
44 Cal. Rem. 450-200-1R	90382
44 Ruger Old Army 456-220-1R	90384



WARNING Melting lead and casting lead objects will expose you and others in the area to lead, which is known to the State of California to cause reproductive harm and cancer. For more information, www.P65Warnings.ca.gov. See instructions on REDUCING EXPOSURE supplied with product.

LOAD SLUGS FOR LESS THAN STANDARD TRAPLOADS



Lee Slug Mold

Load slugs for less than standard trap loads. The LEE DRIVE KEY slug is loaded in standard trap hull with standard wad and conventional folded crimp. Slug loads are produced with any standard shot shell reloading press.

Lee Slug Mold features the exclusive drive key. The drive key positively rotates the slug in rifled shotgun barrels and doubles as a support rib allowing use of a standard trap wad—no need for a support wad or base filler. Sabot wad design outperforms rifled slugs in rifled slug barrels. Velocity and accuracy meet and exceed expensive factory loaded rifled slugs. Molds feature self centering automatic core pins for maximum speed and convenience. Mold is complete with sprue plate, handles and complete instructions with suggested loads.

SHOTGUN SLUG MOLD	1 OZ.	12 GA.	90281	55.98
SHOTGUN SLUG MOLD	7/8 OZ.	12 GA.	90282	55.98

EXCLUSIVE DRIVE KEY POSITIVELY ROTATES THE SLUG IN RIFLED BARRELS AND ELIMINATES THE NEED FOR SUPPORT WADS OR BASE FILLERS; ASSURES POSITIVE AND SMOOTH DISCARD OF THE SABOT WAD.



GUARANTEED MORE ACCURATE than factory slugs or your money back



18 CAVITY BUCKSHOT BULLET MOLDS



Lee 18 Cavity Buckshot Bullet Molds

Precision-machined molds produce 18 linked pellets per cast. Each cast produces enough pellets to load two 12 gauge shotshells. Easily cast 3000 pellets per hour. Handles included. Packed into a nicely molded storage box that allows you to store your Buckshot mold with handles installed.

BALL DIAMETER .240 #4 BUCKSHOT	90028	83.00
BALL DIAMETER .300 #1 BUCKSHOT	92068	
BALL DIAMETER .320 0 BUCKSHOT	92077	
BALL DIAMETER .330 00 BUCKSHOT	90486	
BALL DIAMETER .360 000 BUCKSHOT	90192	

WARNING Melting lead and casting lead objects will expose you and others in the area to lead, which is known to the State of California to cause reproductive harm and cancer. For more information, www.P65Warnings.ca.gov. See instructions on REDUCING EXPOSURE supplied with product.

LOAD SHOTGUN SHELLS, STEEL OR LEAD SHOT, TO LOOK AND SHOOT LIKE NEW

Lee Load-All II

Lee Load-All II shotgun shells not only look better than those loaded on machines costing hundreds of dollars, but they usually have more uniform velocity and patterns. You can load just as fast as with any other brand of loader costing up to \$200.

Twenty-four shot and powder bushings are included free. The bushings alone can cost several dollars each from other manufacturers— and they're not as accurate as those made by Lee. Only Lee supplies molded bushings.

This is a time proven tool. There are hundreds of thousands in use world wide: in nearly forty years, we have yet to see one worn out. Written two-year unconditional guarantee and a lifetime warranty.

LEE LOAD-ALL II	96.98
12 GAUGE	90011
16 GAUGE	90015
20 GAUGE	90012



Load-All Options

CONVERSION TO ANOTHER GAUGE

The Load-All II can be easily and economically converted to another gauge with the conversion kit. The entire die carrier is replaced so no adjustments are needed. The conversion kit includes the die carrier, steel sizer, wad guide, shell holder, load data and instructions.

CONVERSION KIT 29.98

12 GAUGE	90070
16 GAUGE	90071
20 GAUGE	90072

LEE ADJUSTABLE SHOT DIPPER

Accurately measure lead, bismuth and steel. Telescoping cup adjustable from 7/8 to 1 7/8 oz. Calibrated for lead shot. Works perfect for large pellet sizes. With steel, simply count out the pellets or weigh and set dipper accordingly.

90973 4.98

LEE

BULK PERMIT
U.S. POSTAGE
PAID
PEWAUKEE WI 53072
PERMIT NO. 2513

No Print White Only

MAX SIZE 2.875 X 1.625 Message Area

MAX SIZE X 1.625 Address Area

MIN SIZE 3.75 X 1.625 Address Area

No Print White Only



Thank you for choosing
**LEE PRECISION
PRODUCTS**

FROM THE CORNER of a one-car garage to nearly two acres under roof — for more than 65 years, the LEE family still continues to provide the best value in American made reloading equipment. Our family looks forward to another lifetime of supplying the best, most economical reloading equipment in the business. • JOHN LEE | PRESIDENT

The Lee Guarantee

LEE RELOADING PRODUCTS are guaranteed not to wear out or break from normal use for two full years or they will be repaired or replaced at no charge, if returned to the factory. Any **LEE PRODUCT** of current manufacture, regardless of age or condition, will be reconditioned to new—including new guarantee—if returned to the factory with payment equal to half the current retail price ☒

AUTO BENCH PRIME | AUTO BREECH LOCK PRO | AUTO-DRUM | BREECH LOCK | CLASSIC CAST SIX PACK PRO | LEVER PRIME SYSTEM | LEE LOADER | LOAD-ALL II | RGB FACTORY CRIMP | PACESETTER | PERFECT POWDER MEASURE | SAFETY SCALE | AUTO-PRIME BULGE BUSTER | MICRO-BAND DRIVE KEY | R-E-A-L | ARE TRADEMARKS OF LEE PRECISION, INC.

www.leeprecision.com

LEE
LEE PRECISION, INC.